

weka

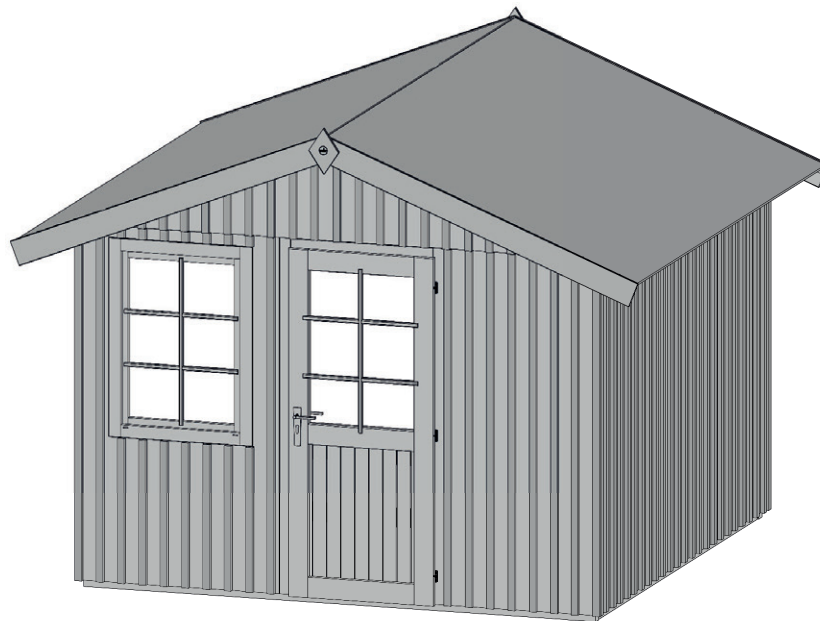

Schwedenhaus in Elementbauweise





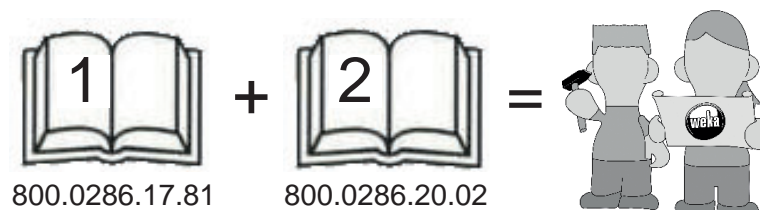

410.3030.20000
410.3030.23000

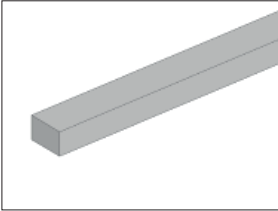
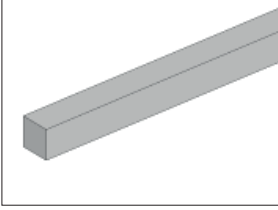
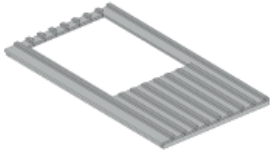

Montage-, Bedienungs- und Wartungsanleitung

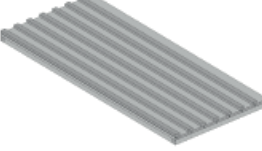
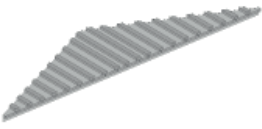



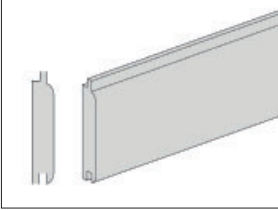
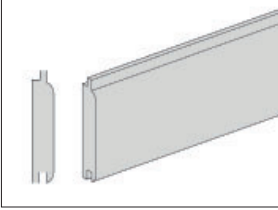
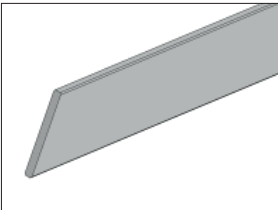
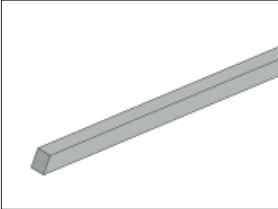
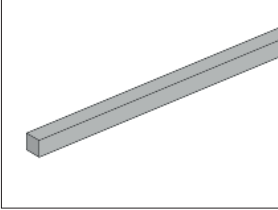

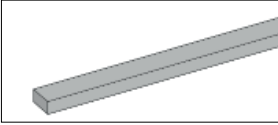
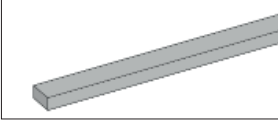
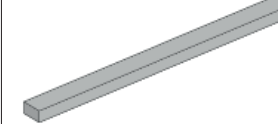
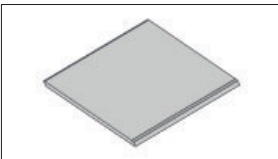

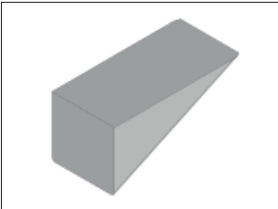



Stand: 2614

Pos	Bild	Abmessung (mm)	Anzahl (Stück)
			410.2525.2x001
①	R004.3013.3000 	45/70/3000	4
②	R004.3012.2830 	45/45/2830	4
③	B410.01.0002 B410.01.0802 	82/1167/2030	1
④	B410.01.0003 B410.01.0803 	82/725/2030	6
⑤	B410.01.0008 B410.01.0808 	82/770/2030	6
⑥	B410.01.0007 B410.01.0807 	82/896/2030	1
⑦	B410.01.0009 B410.01.0809 	82/625/3030	2

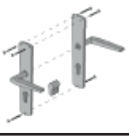
Pos	Bild	Abmessung (mm)	Anzahl (Stück)
			410.2525.2x001
8	B410.01.0010 	82/600/3030	3
9	R002.0162.2910 	18,5/96/2910	33
10	R002.0162.3344 	18,5/96/3344	46
-	-	-	-
12	G410.01.0002 G410.01.1002 	18,5/146/1975	4
13	G410.01.0005 	30/30/1955	4
14	G410.01.0004 	28/28/2030	6

Pos	Bild	Abmessung (mm)	Anzahl (Stück)
			410.2525.2x001
15	G410.01.0008 G410.01.0808 	30/60/2870	2
16	G410.01.0009 G410.01.0809 	30/60/3030	2
17	G410.01.0010 G410.01.0810 	22/40/2030	17
18	G100.10.0001 G100.10.1001 	18,5/160/260	2
19	B100.11.3410 B100.11.3470 	53/842/1134	1
20	B100.12.6430 B100.12.6470 	63/965/2030	1
21	-	-	-
22	G410.01.0012 	40/40/104	6

M410.002 410.2525.2x001		Abmessung (mm)	Anzahl (Stück)
Pos	Bild		410.3030.2x001
M1	K001.1050.0004 	5,0 x 100	15
M2	K001.7045.0004 	4,5 x 70	250
M3	K010.6040.0004 	4,0 x 60	120
M4	K001.4040.0004 	4,0 x 40	280
M5	K001.3030.0004 	3,0 x 30	50
M6	K010.5022.0001 	2,2 x 55	770
M7	K011.1320.0001 	2,0 x 13	500
M8	K045.1270.0001 	-	1
M9	K036.3135.0001 	65	1
M10	K100.1010.0006 	2,0/50/50	1
M11	K004.9522.0006 	2,2 x 9,5	2

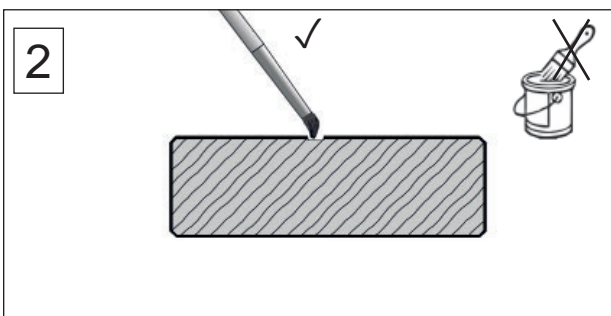
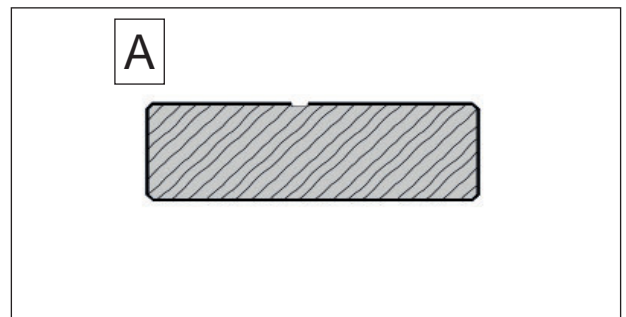
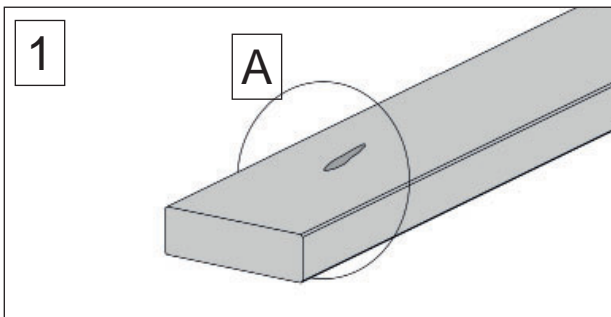
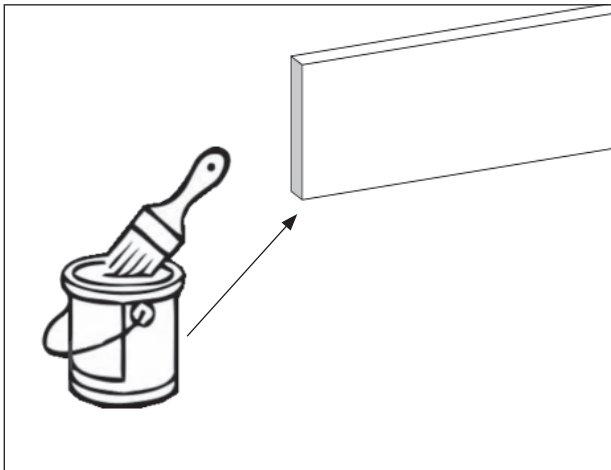
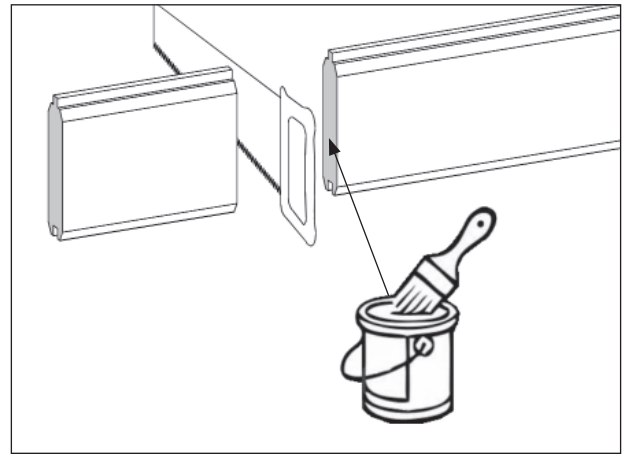
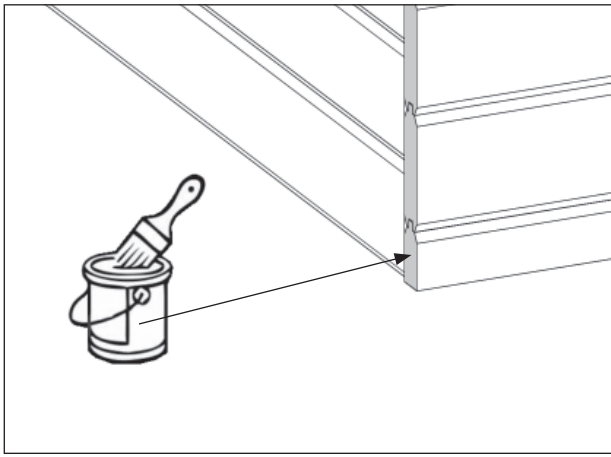

Farbe dünn auftragen und nur auf der Schadstelle.

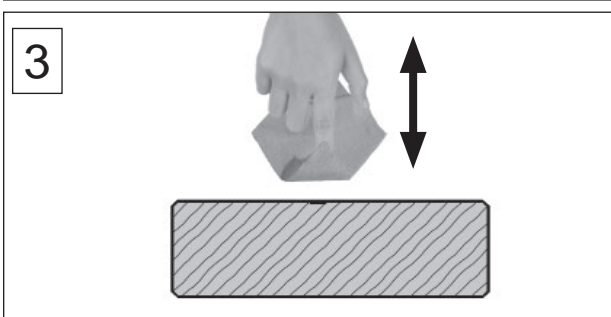
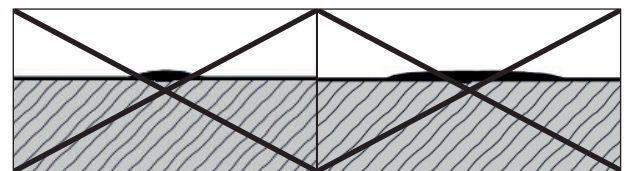

Farbe abtupfen.

Vorgang wiederholen bis die Farbe identisch ist.

Übersicht

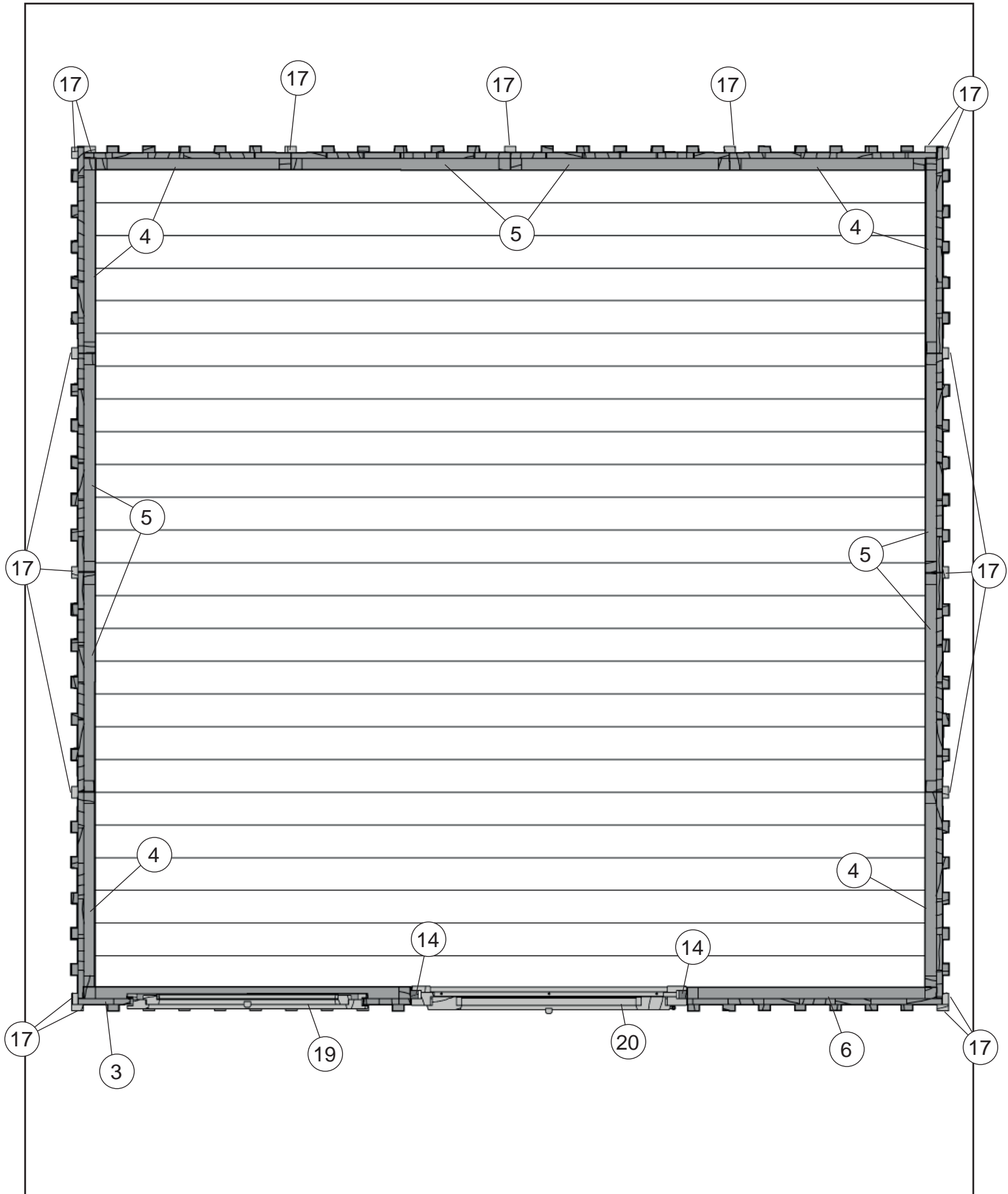

1

	M1 5,0 x 100
--	--------------

$a = a$

$\angle A = \angle A = 90^\circ$

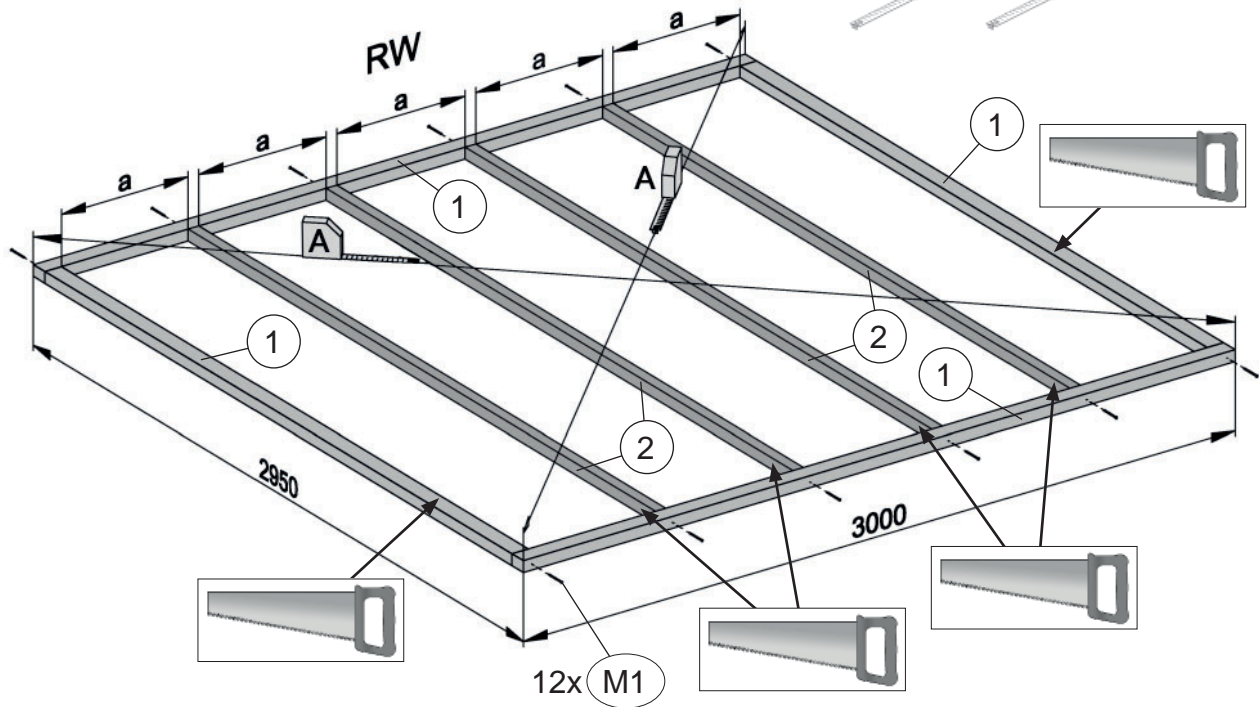

2

	M2 4,5 x 70
---	-------------

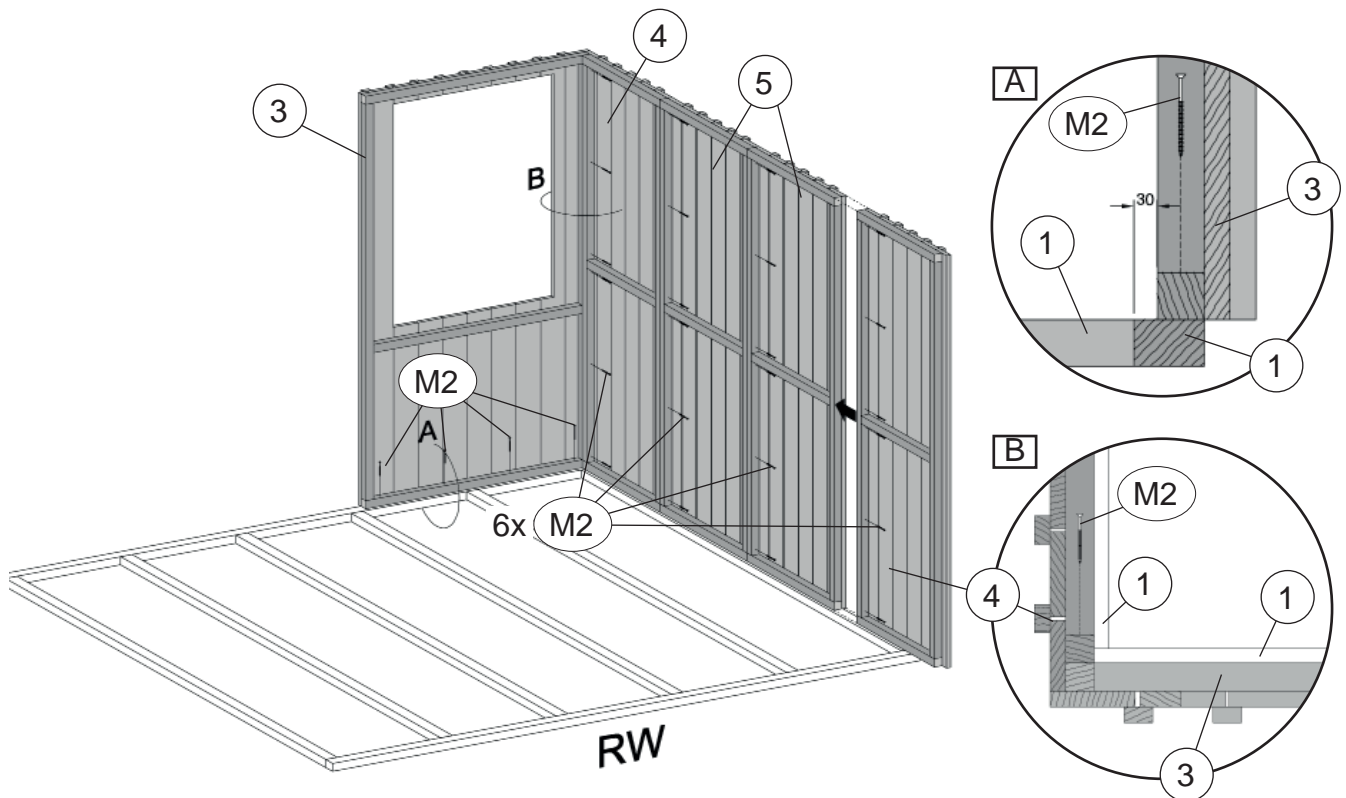

3

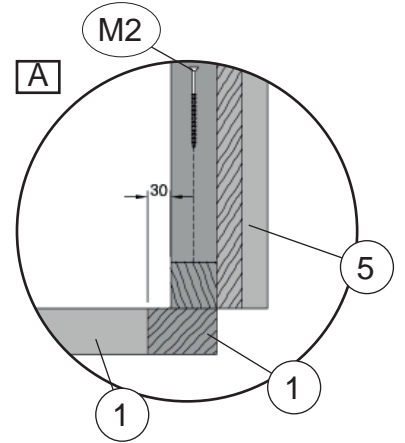
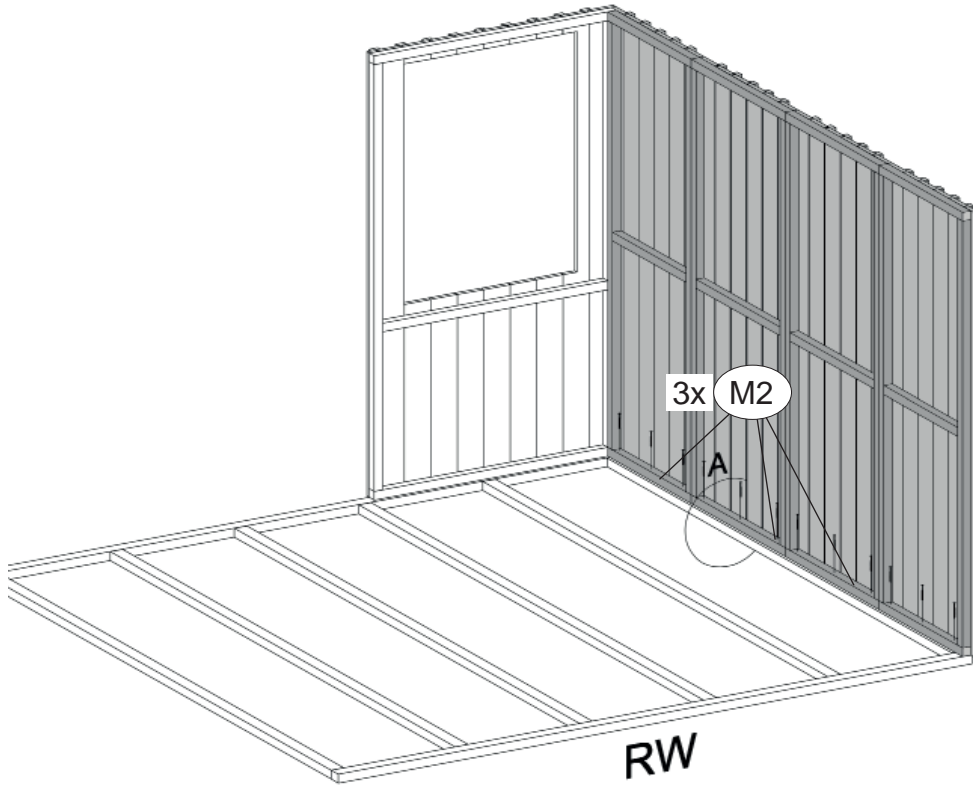
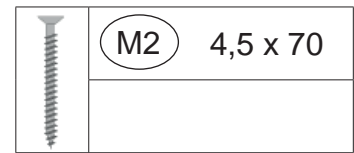

4

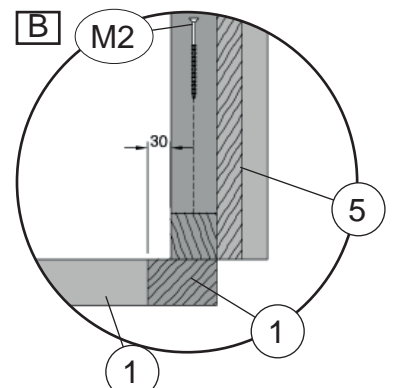
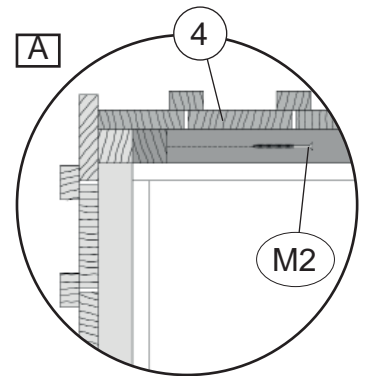
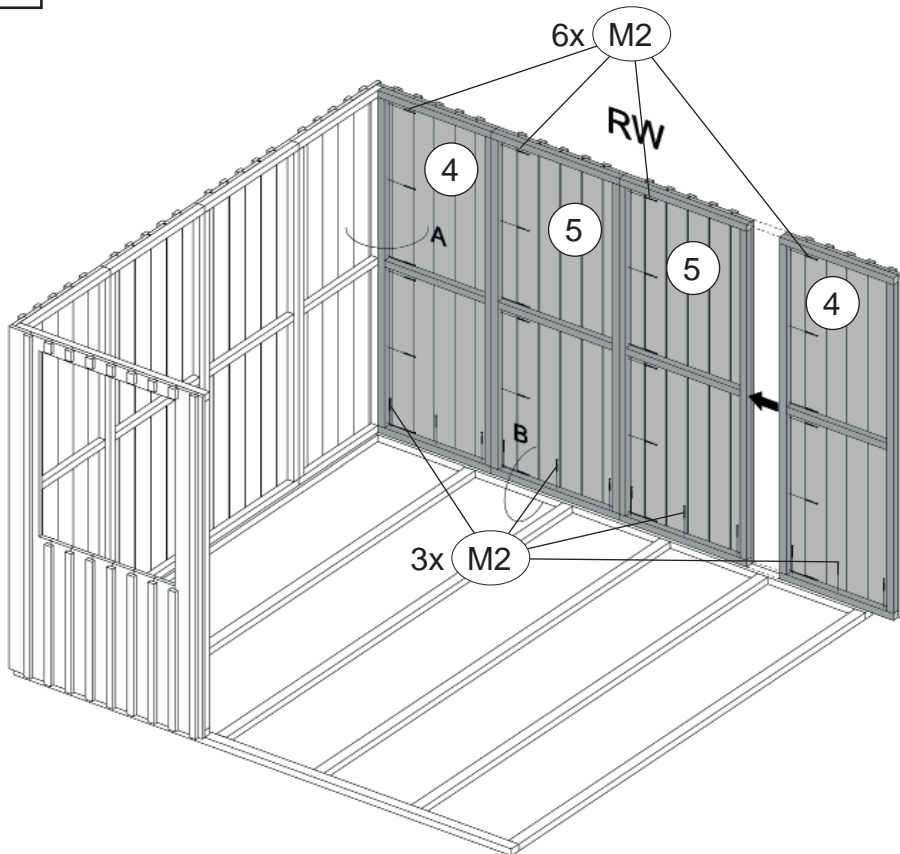
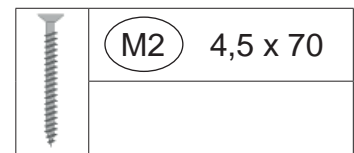

5

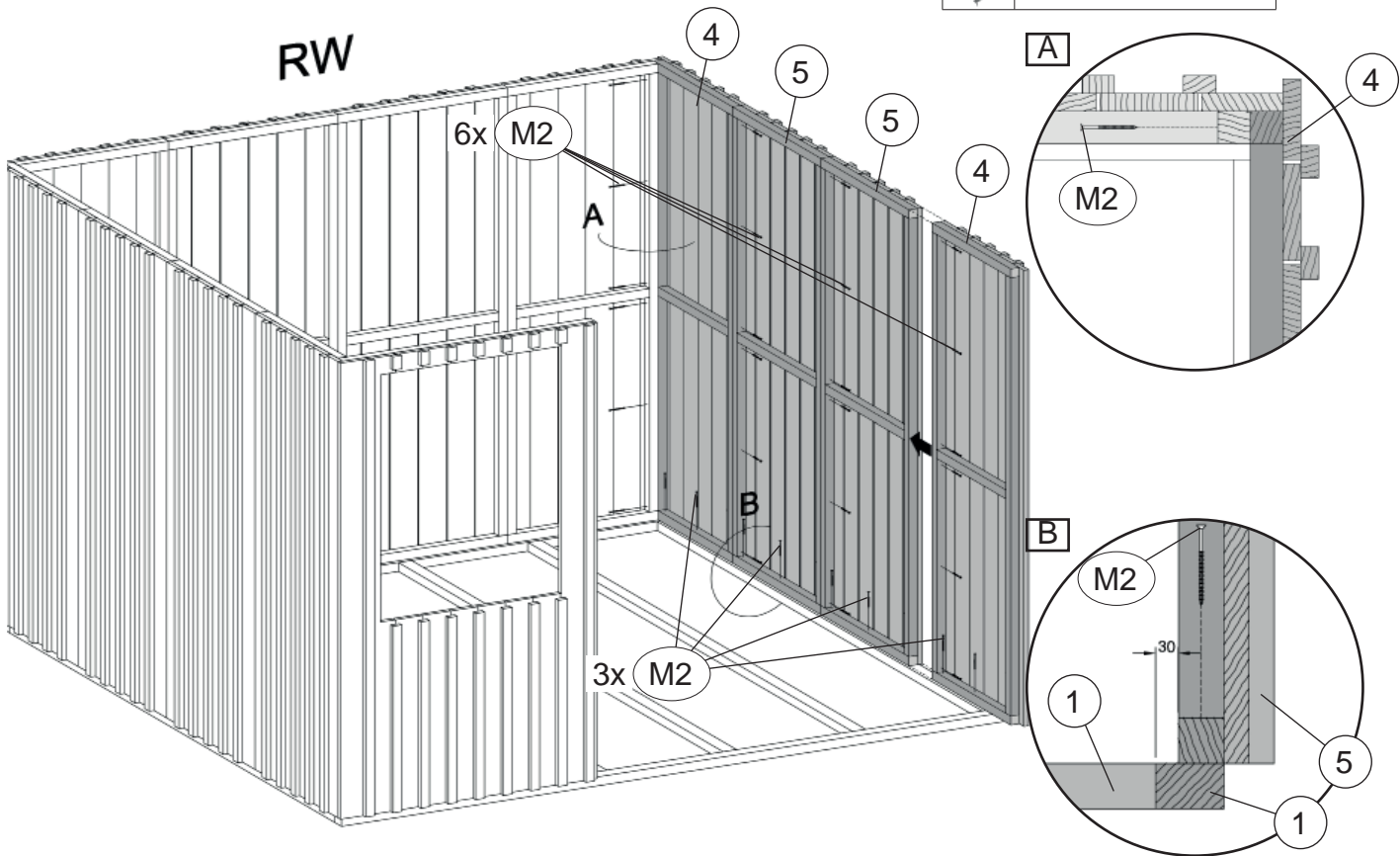
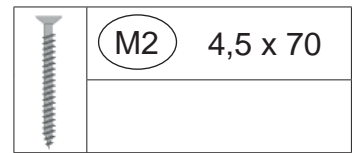

6

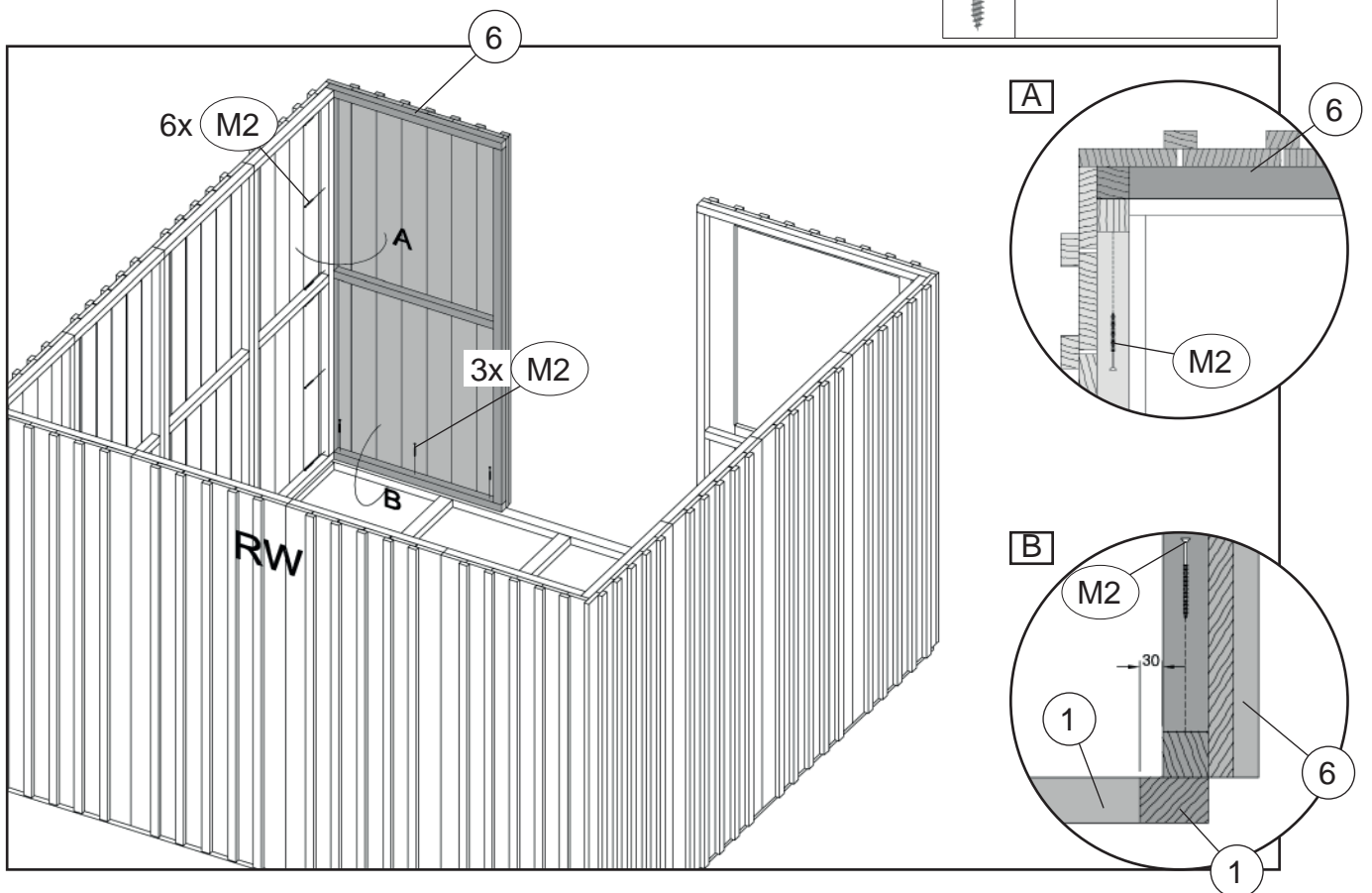
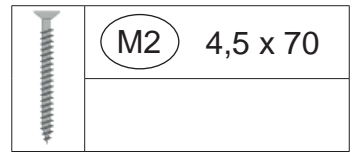

7

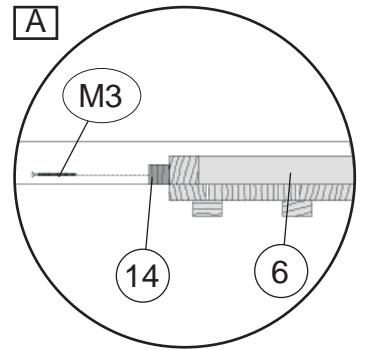
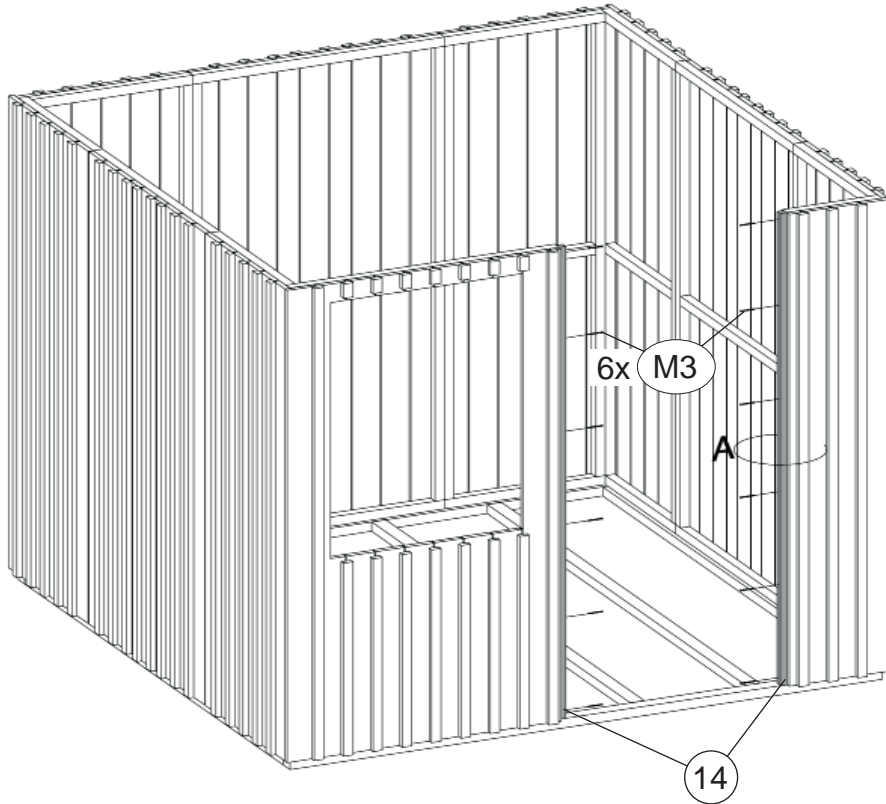
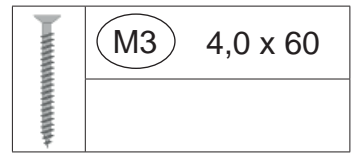

8

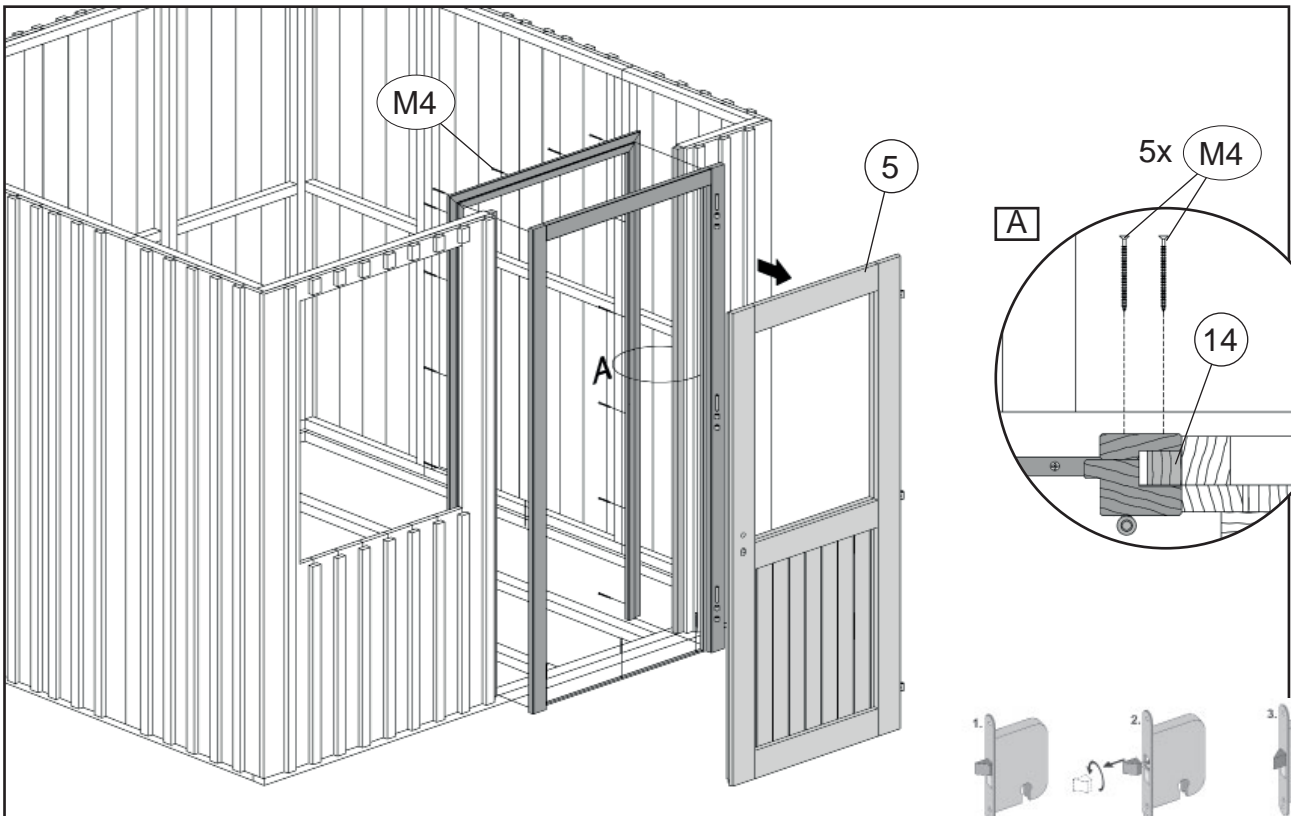
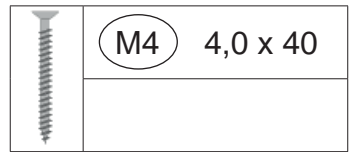

9

	M6 2,2 x 55
---	-------------

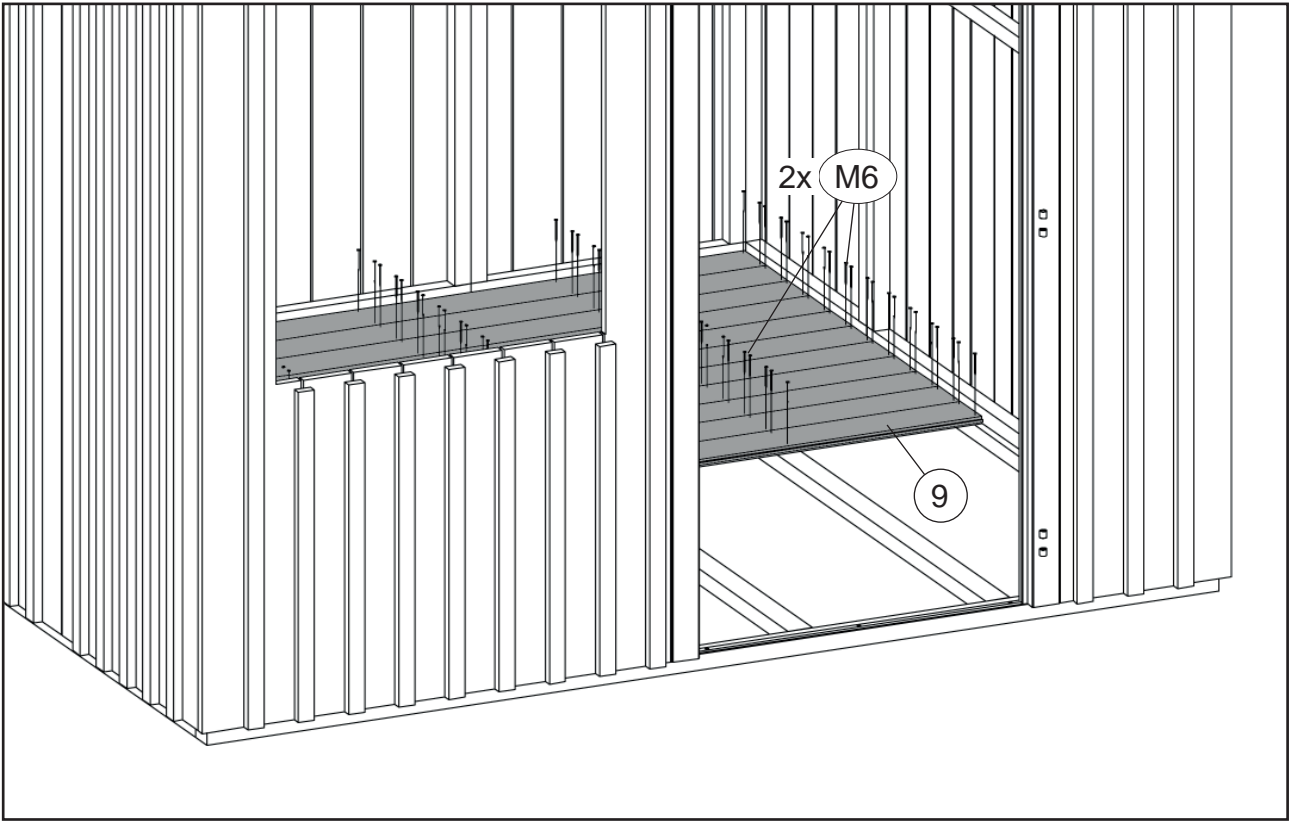

10

	M6 2,2 x 55
---	-------------

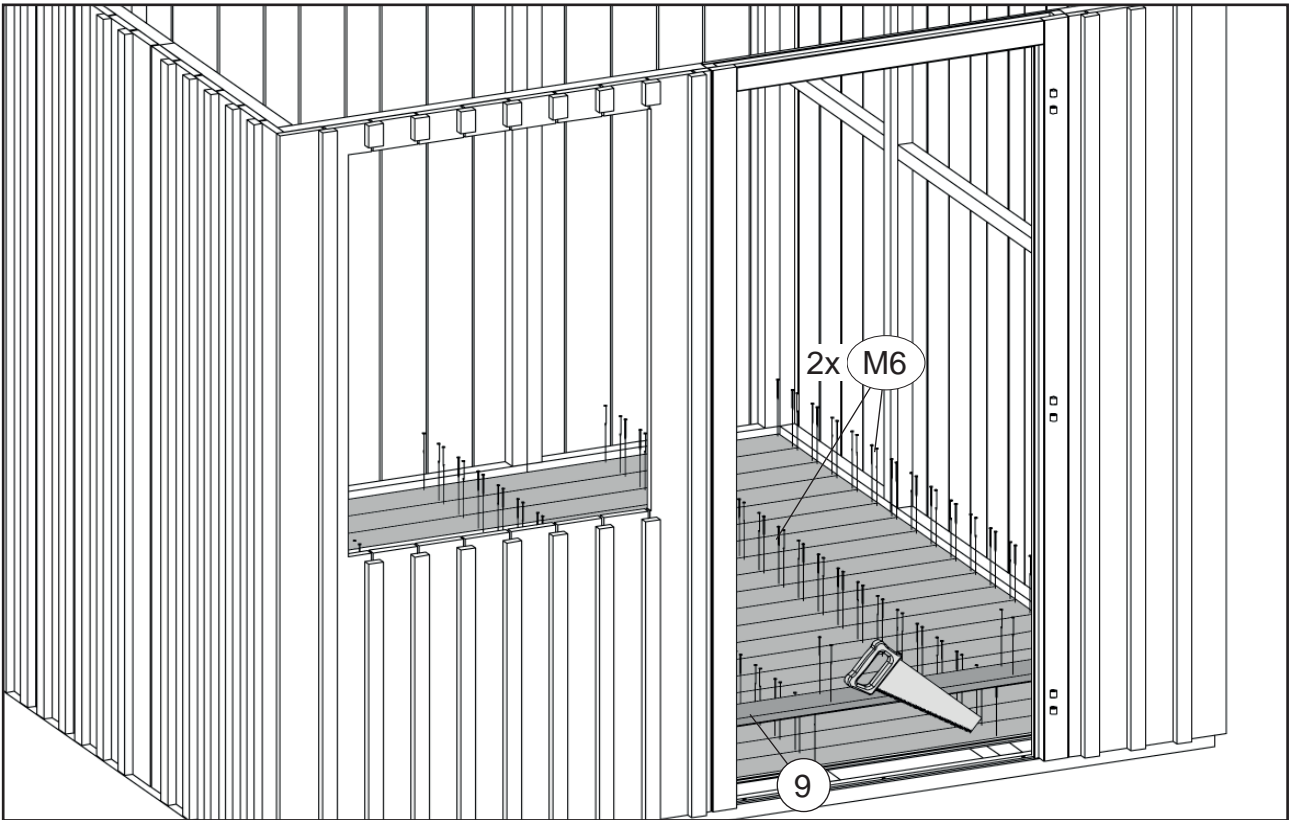

11

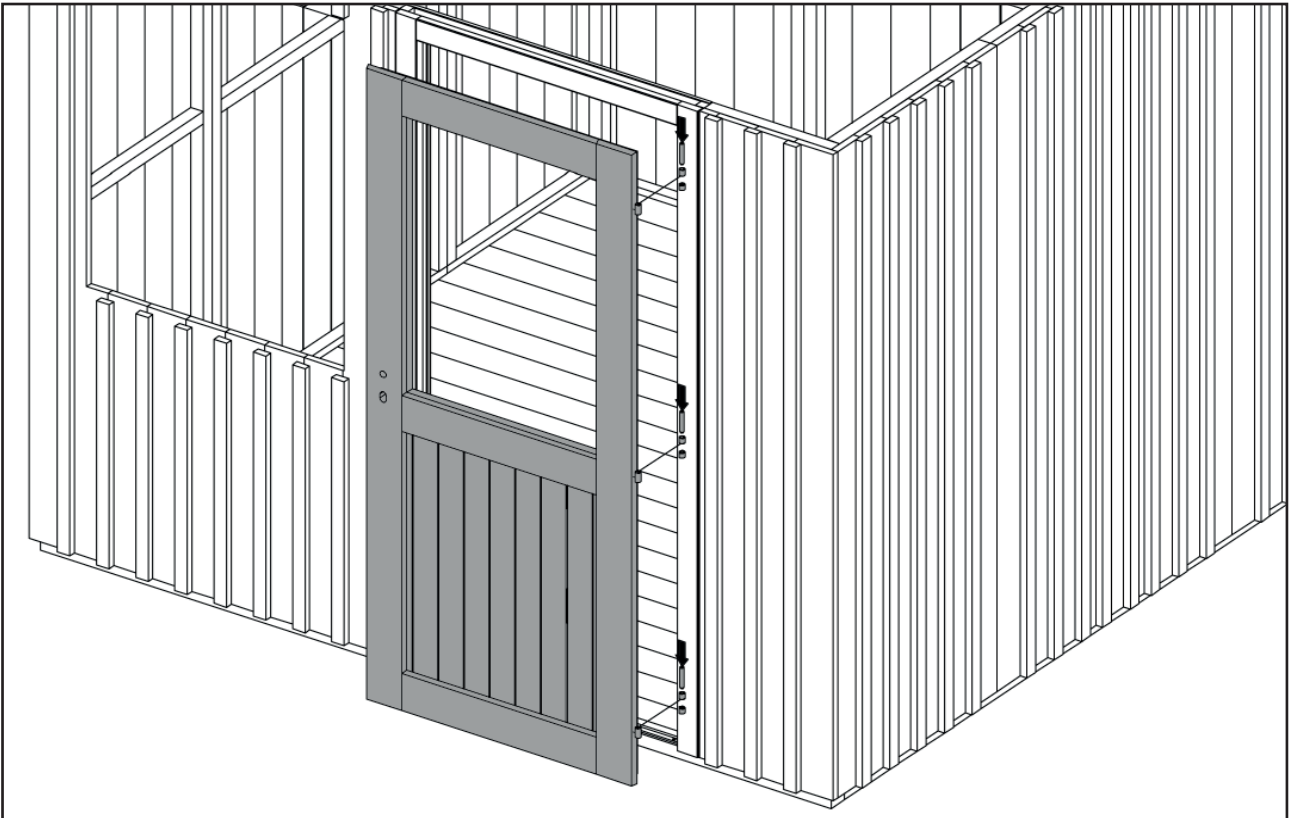

12

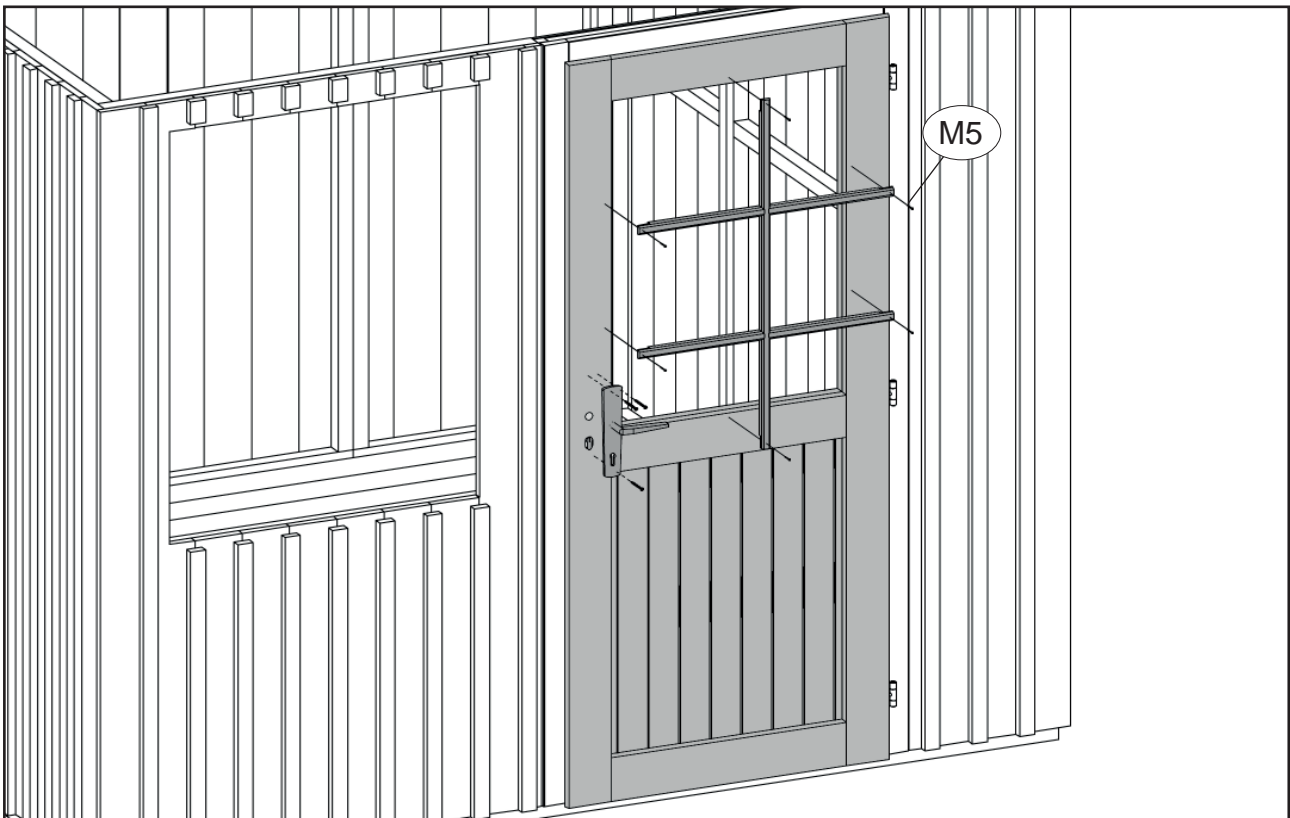
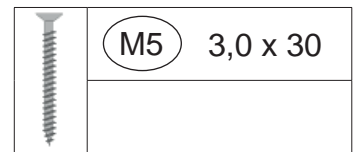

13

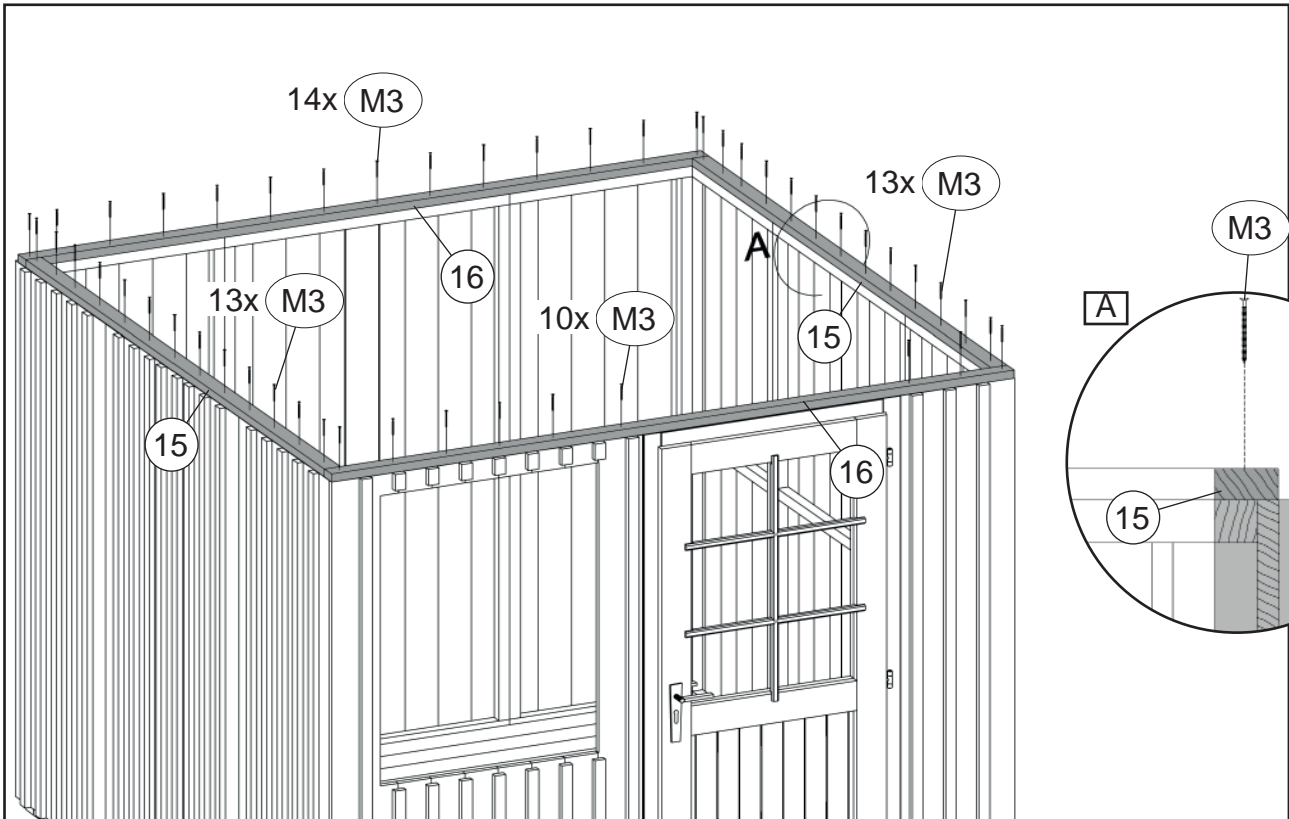
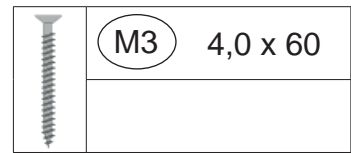

13.1

Draufsicht

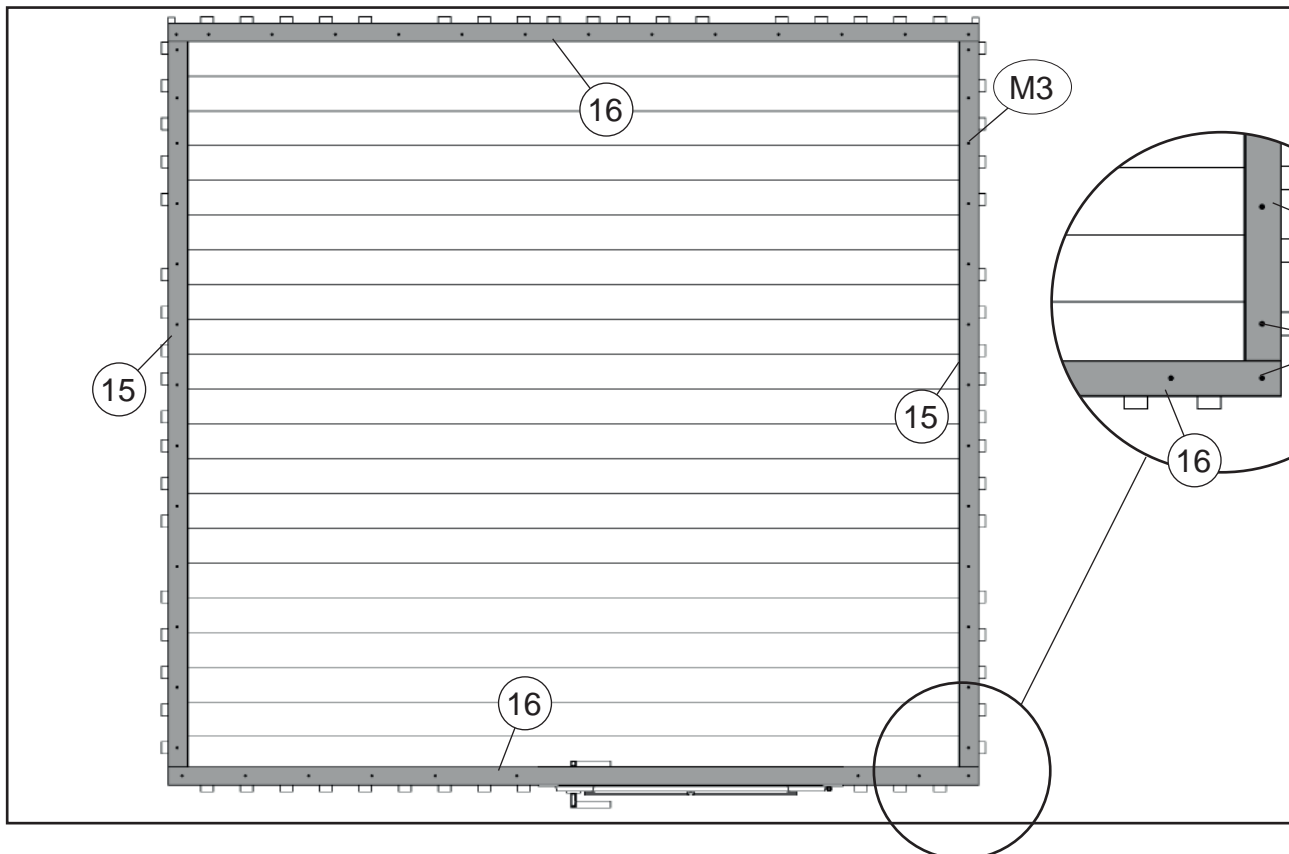
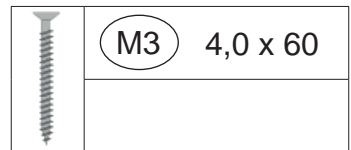

14

	M2	4,5 x 70

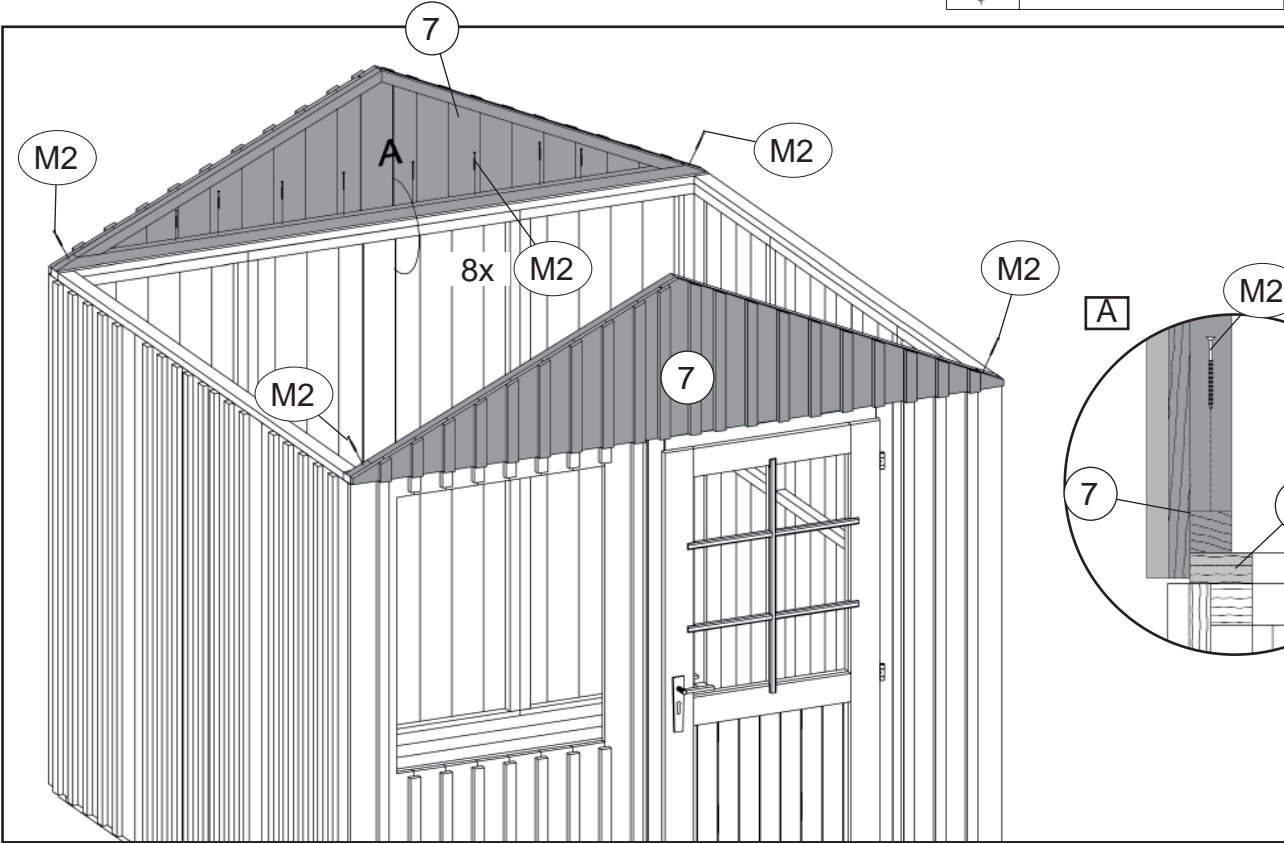

15

	M3	4,0 x 60
	M4	4,0 x 40

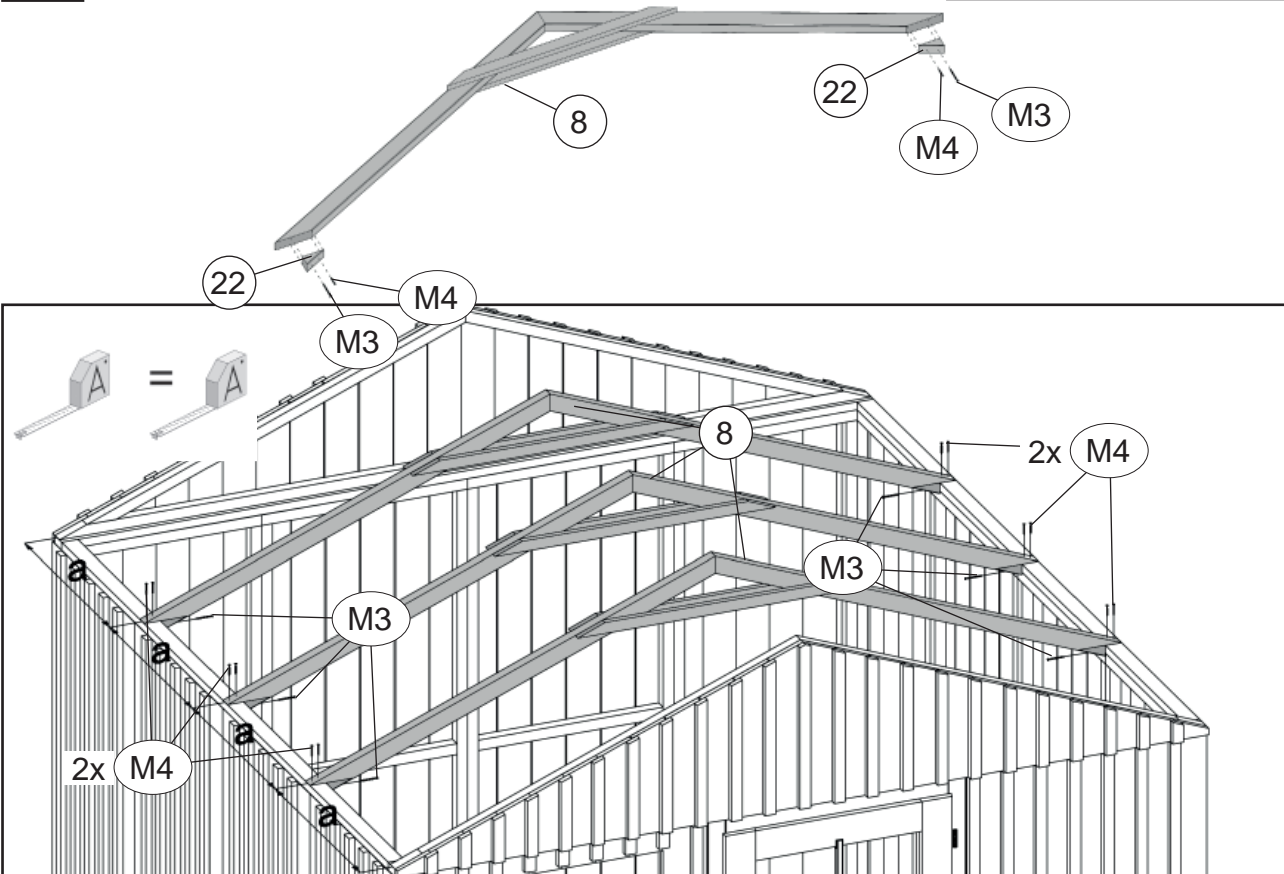

16

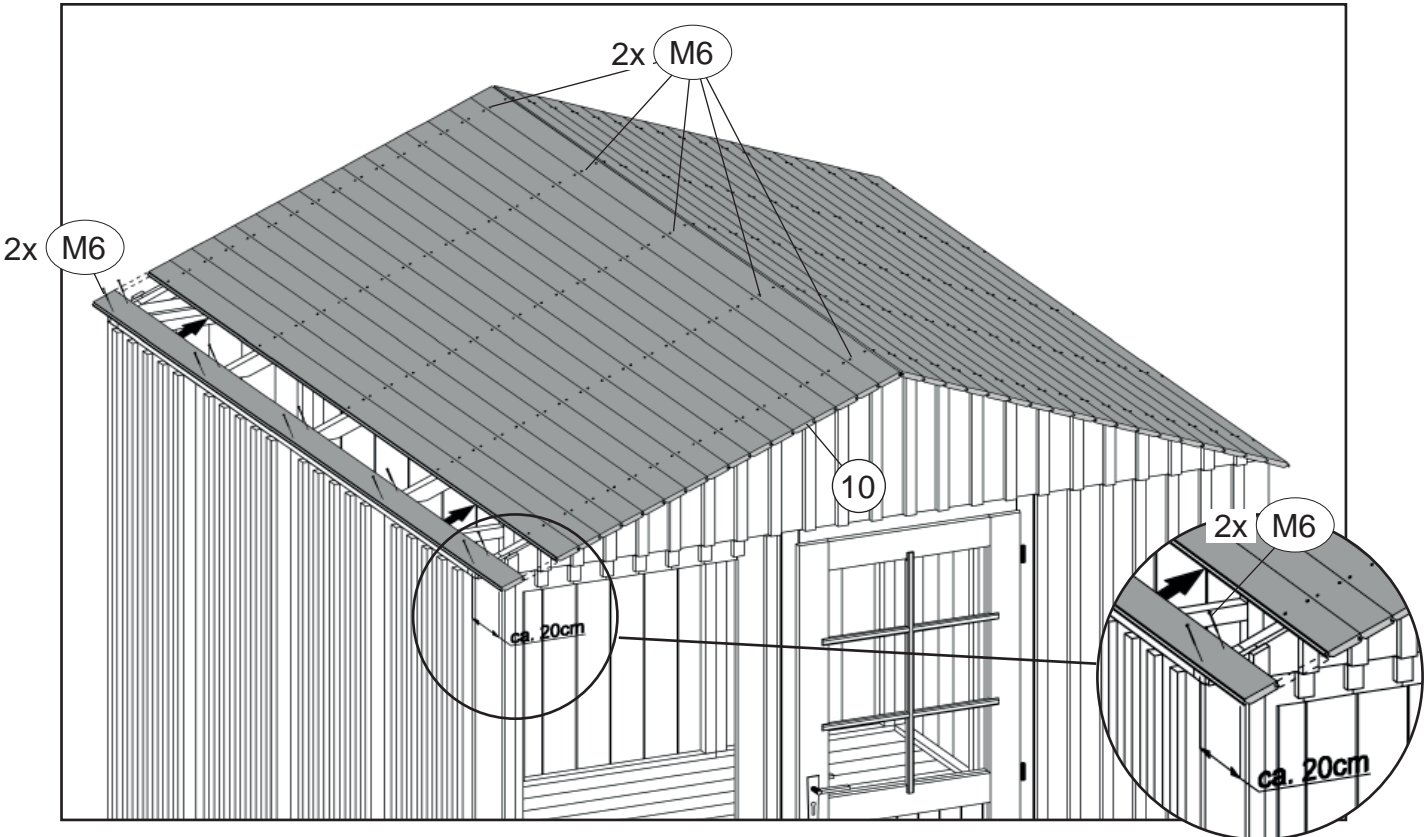
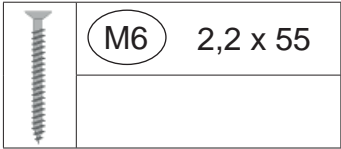

17

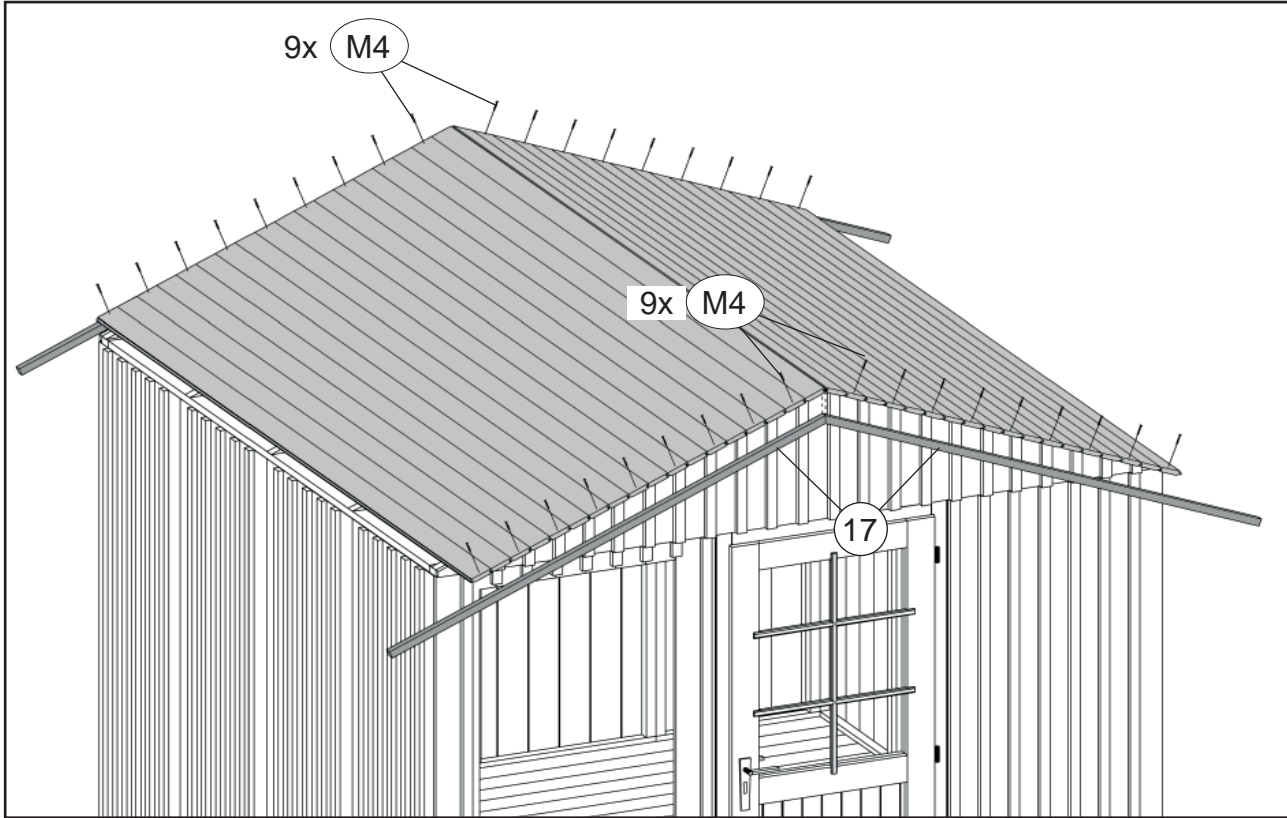
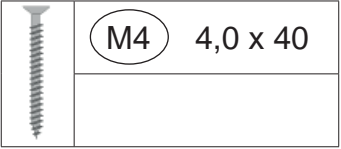

18

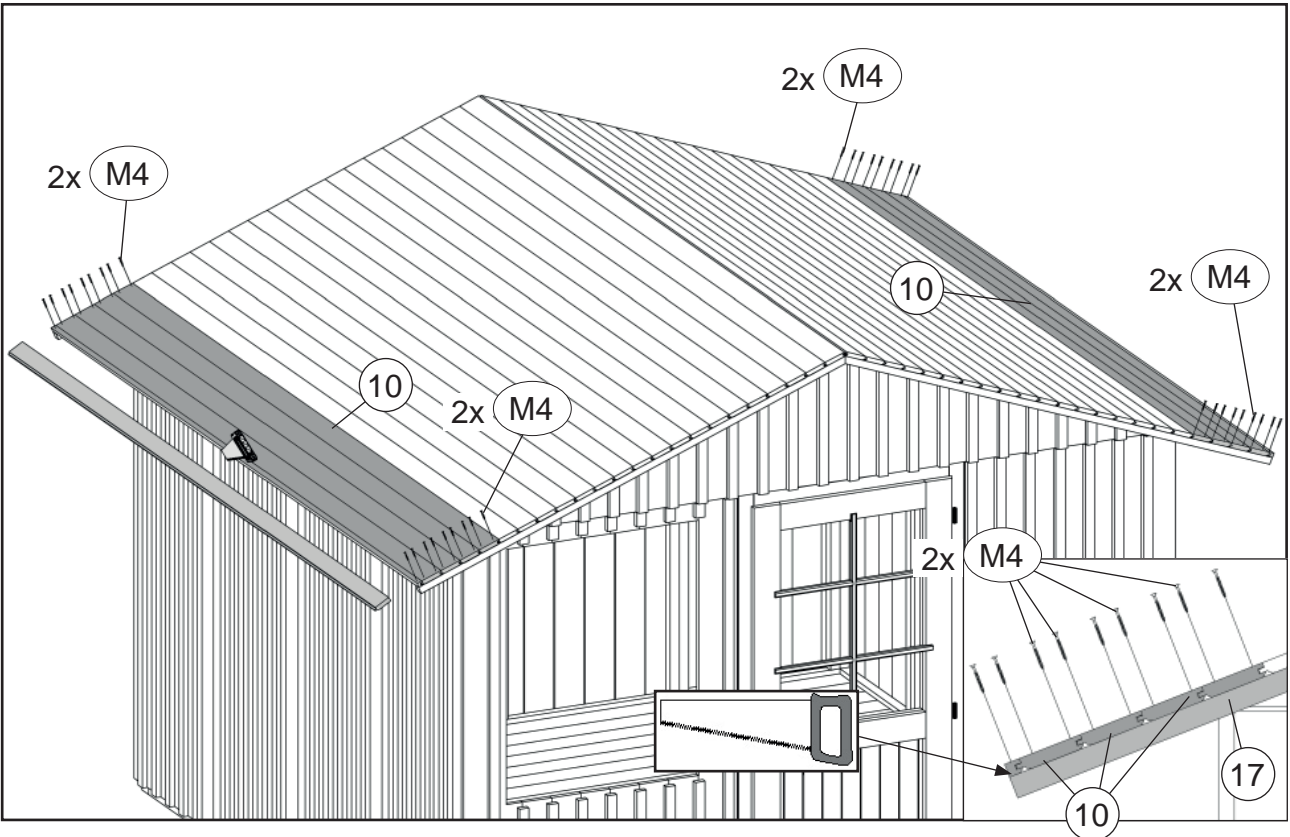
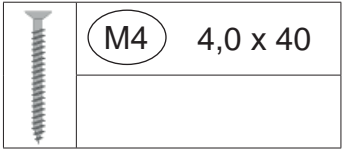

19

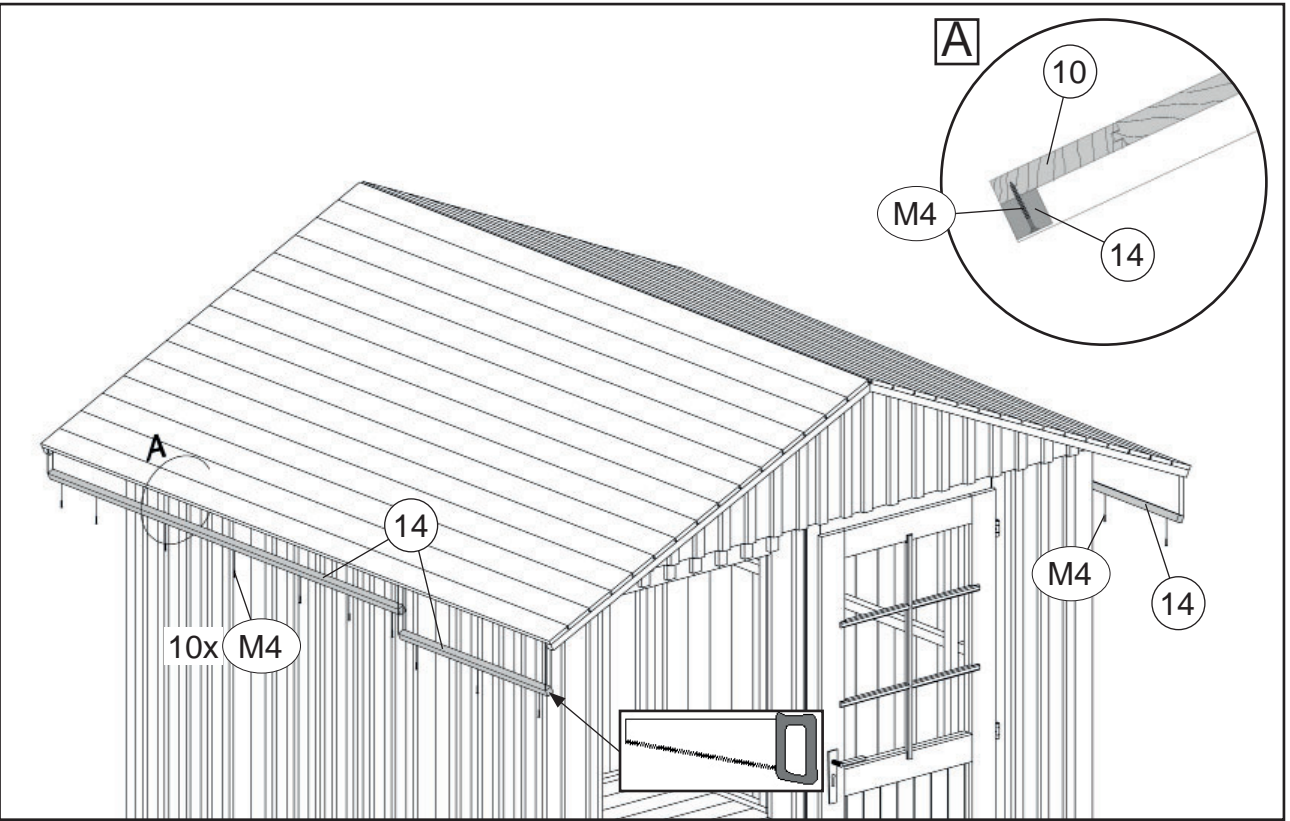
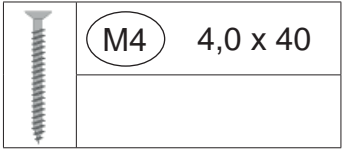

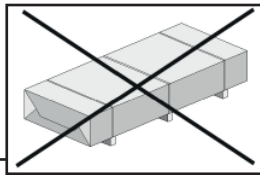
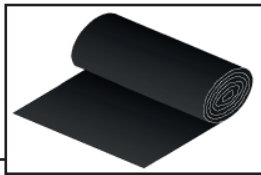

20

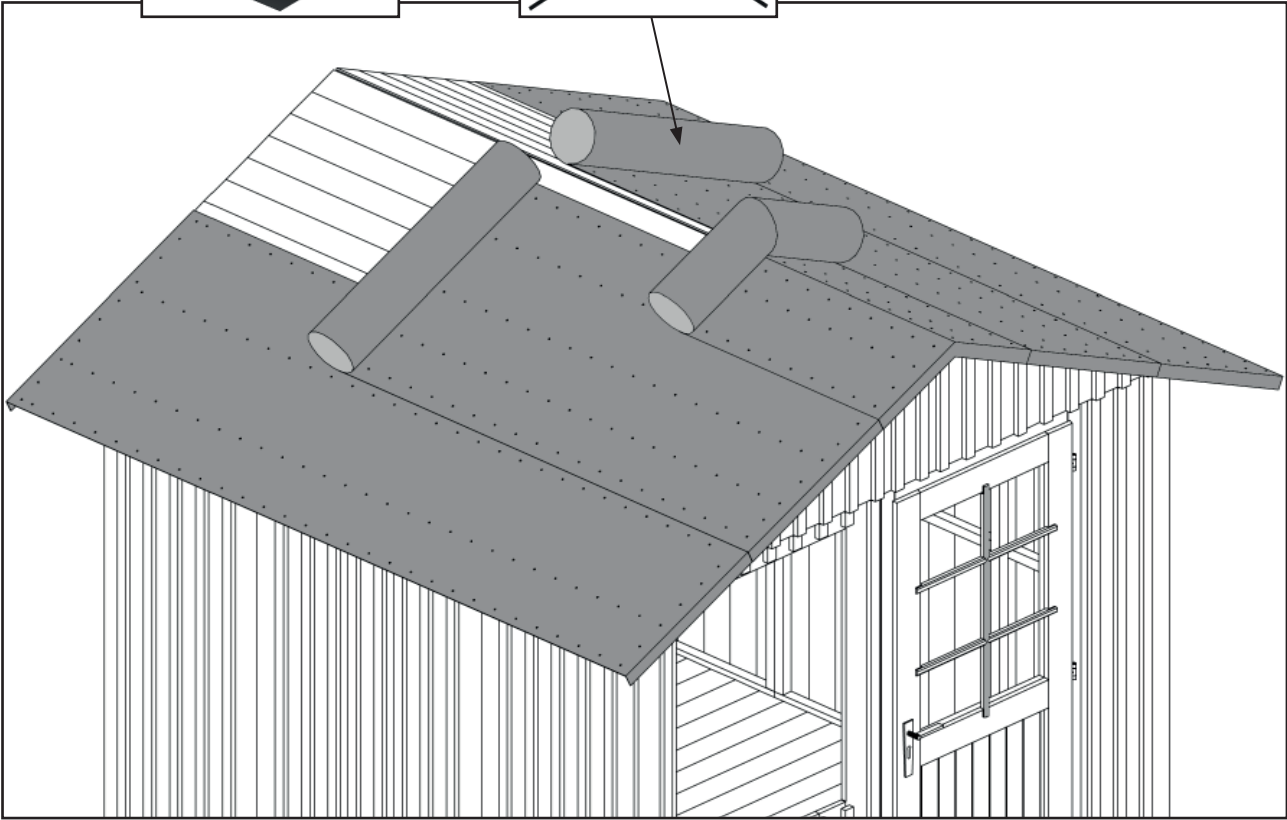

	M7	2,0 x 13
--	----	----------



21

	M10	
	M11	2,2 x 9,5

	M5	3,0 x 30
---	----	----------

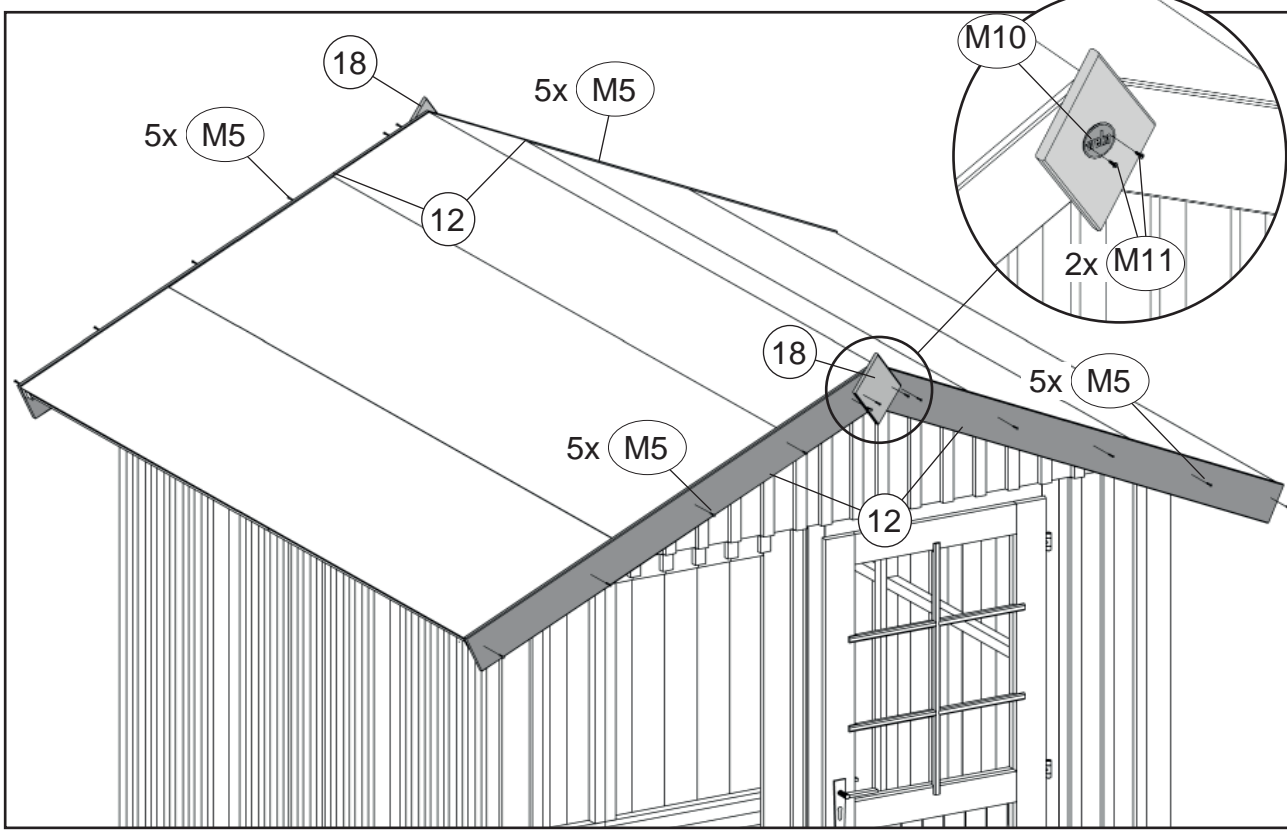

22

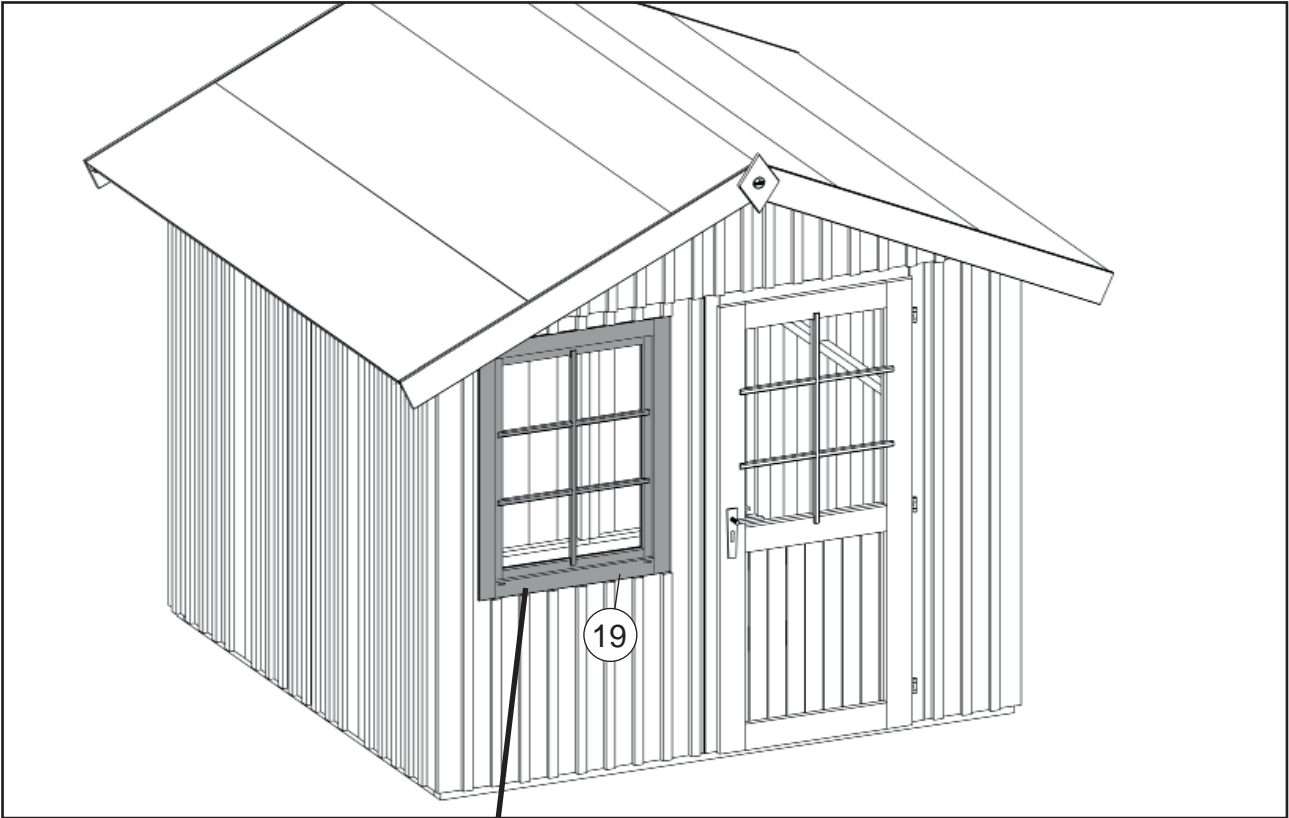

22.1

22.2

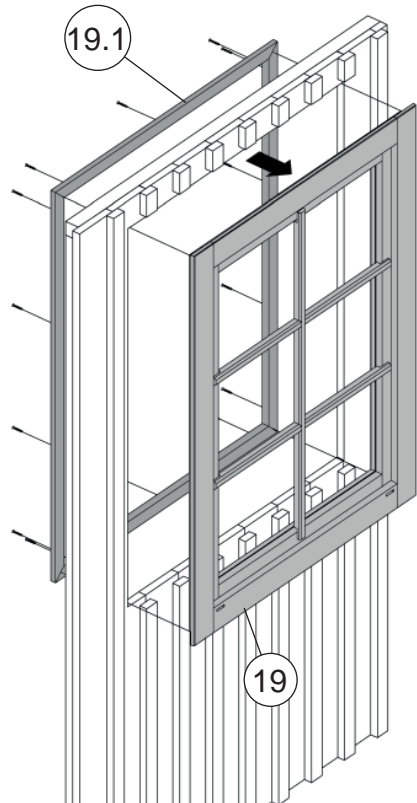
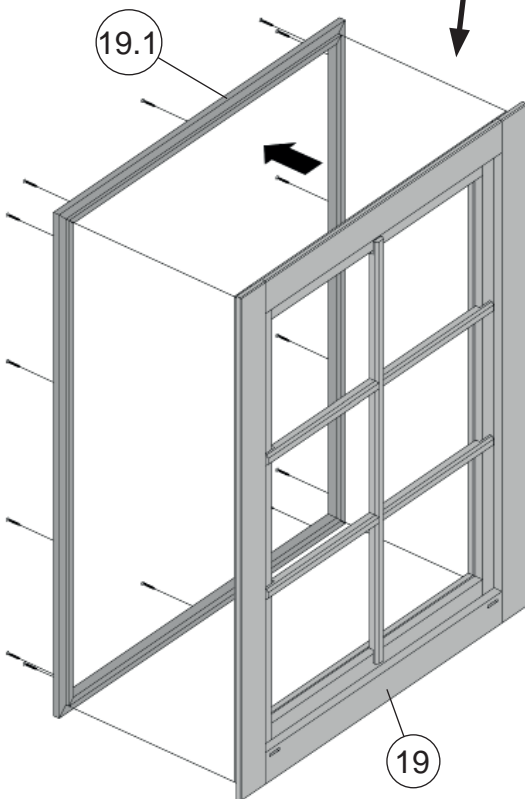

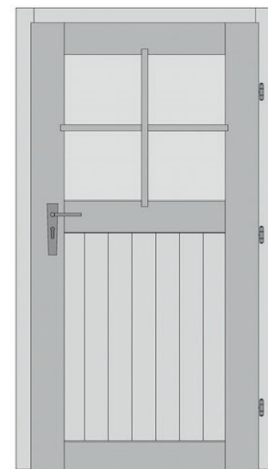
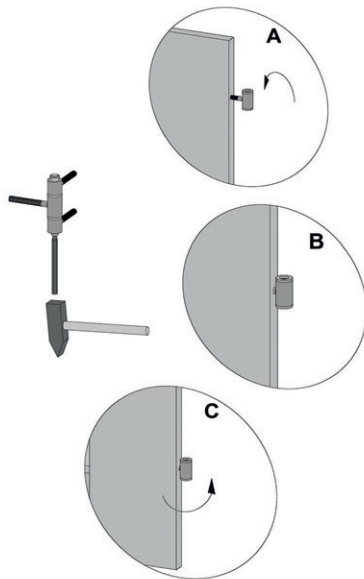
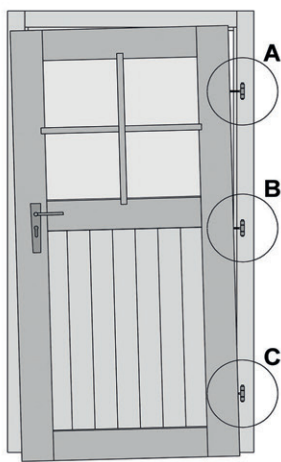
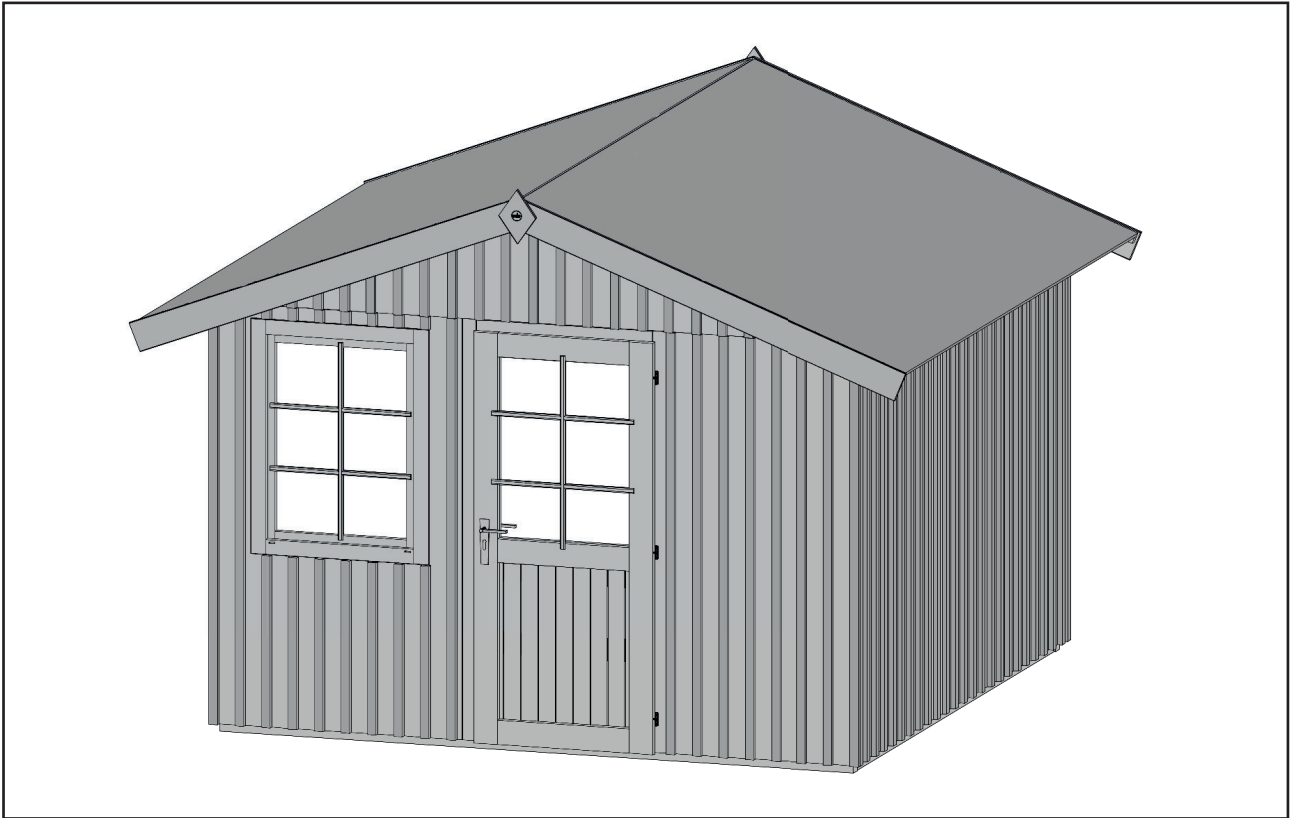

weka

weka Holzbau GmbH

Johannesstr. 16, 17036 Neubrandenburg

Tel.: +49 (0)395 42908-0

Fax: +49 (0)395 42908-83

Mail: info@weka-holzbau.com

Web: www.weka-holzbau.com

MA Art.-Nr.: 800.0286.17.81