

Murano 3  
Art. Nr. 4428719  
1/23

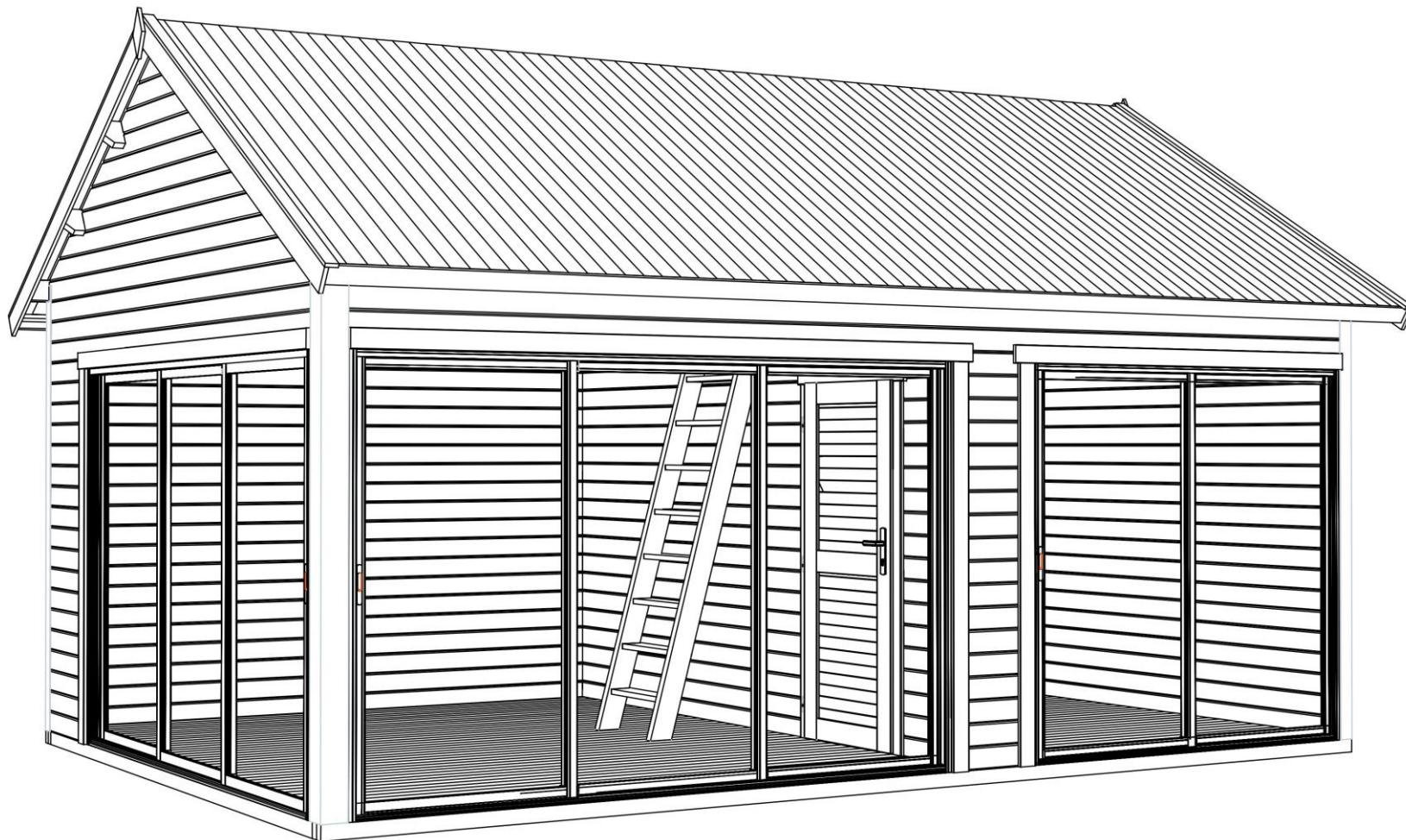

22.03.2023

Art. Nr. 4428719

Groundplan - Grundplan - Plan de masse -  
Planimetria - Plattegrond - Põhiplaan

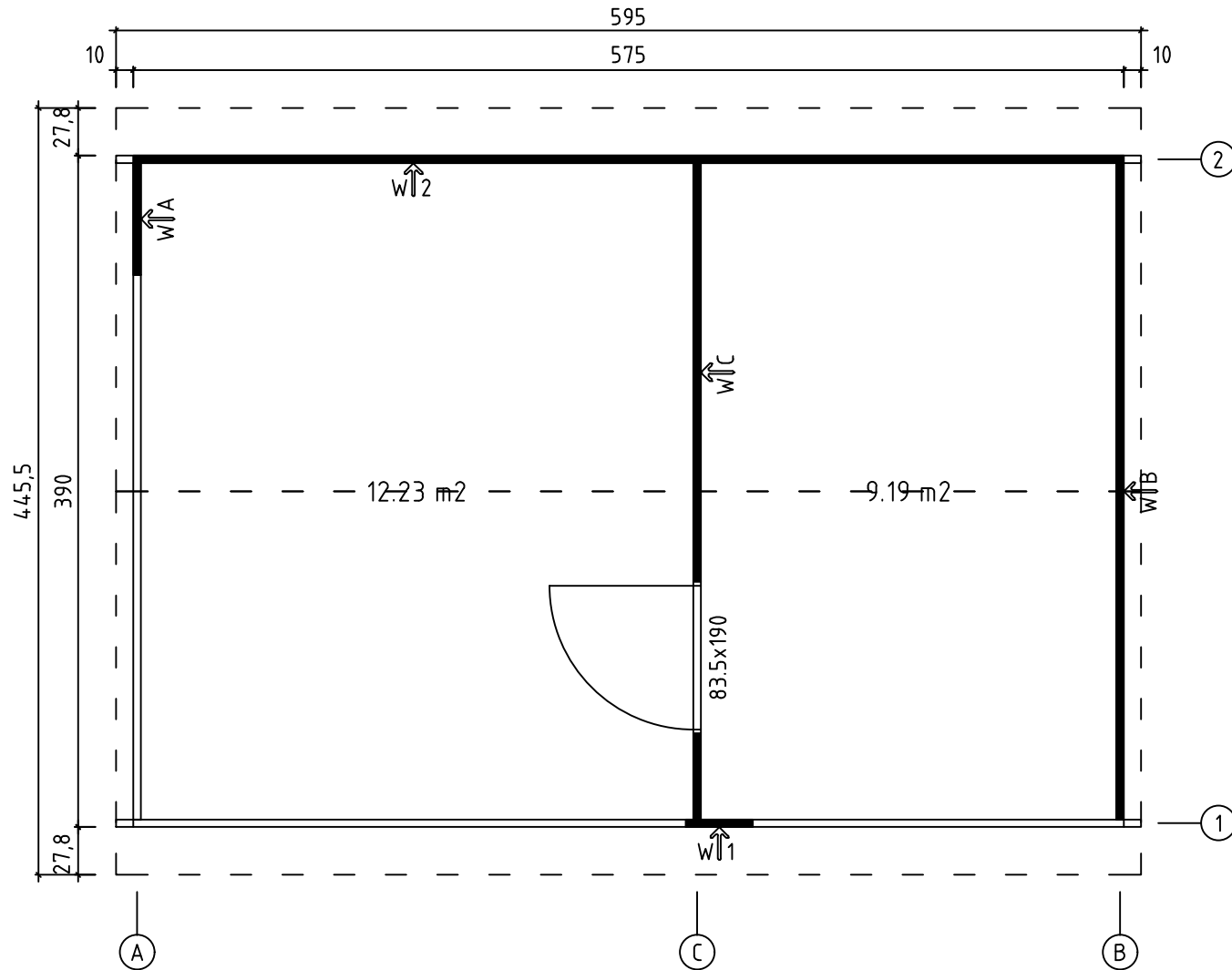



Art. Nr. 4428719

Floor boards - Fussbodenbretter - Plan pose  
plancher - Pavimento - Vloerhout - Põrandalaudis

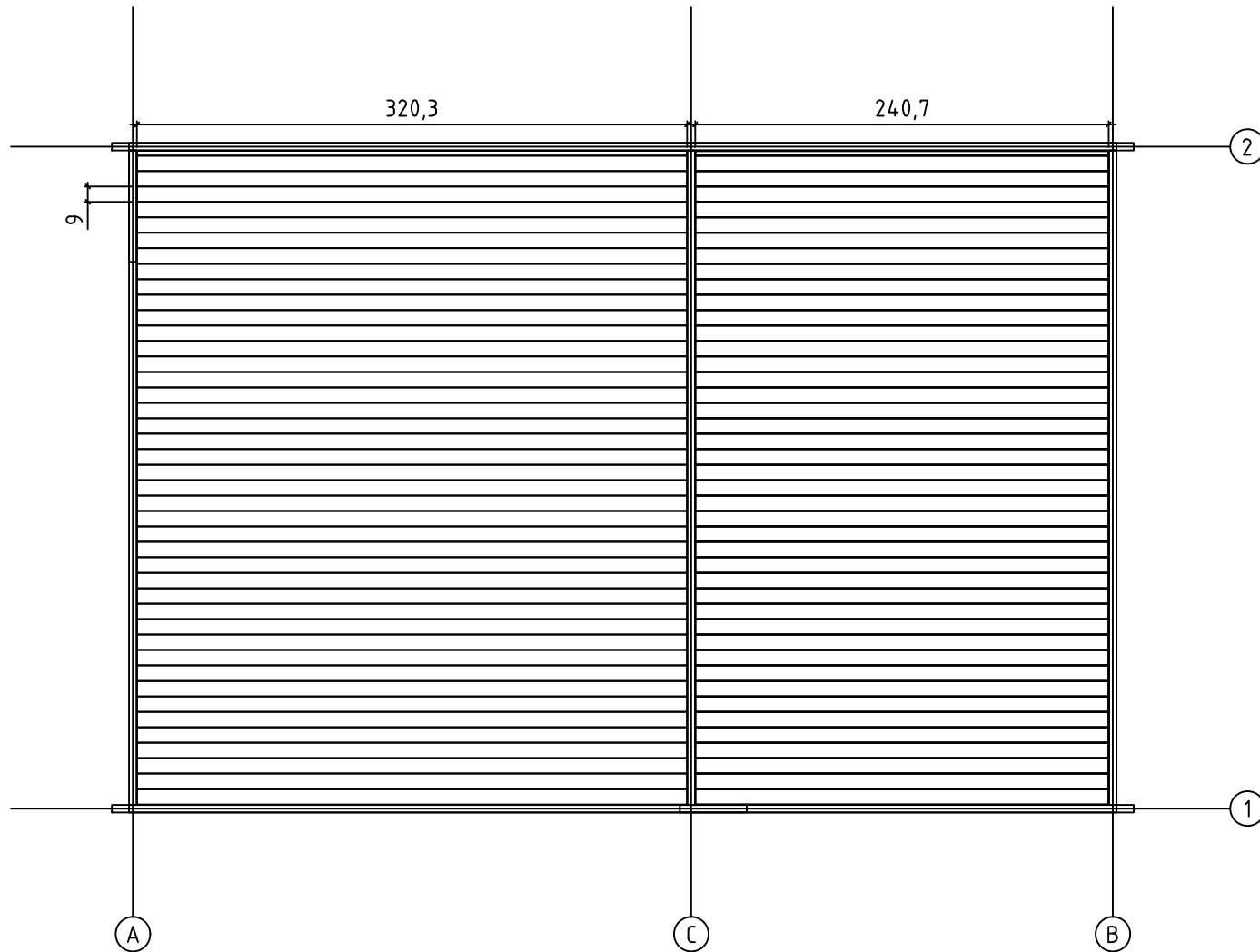

# Art. Nr. 4428719

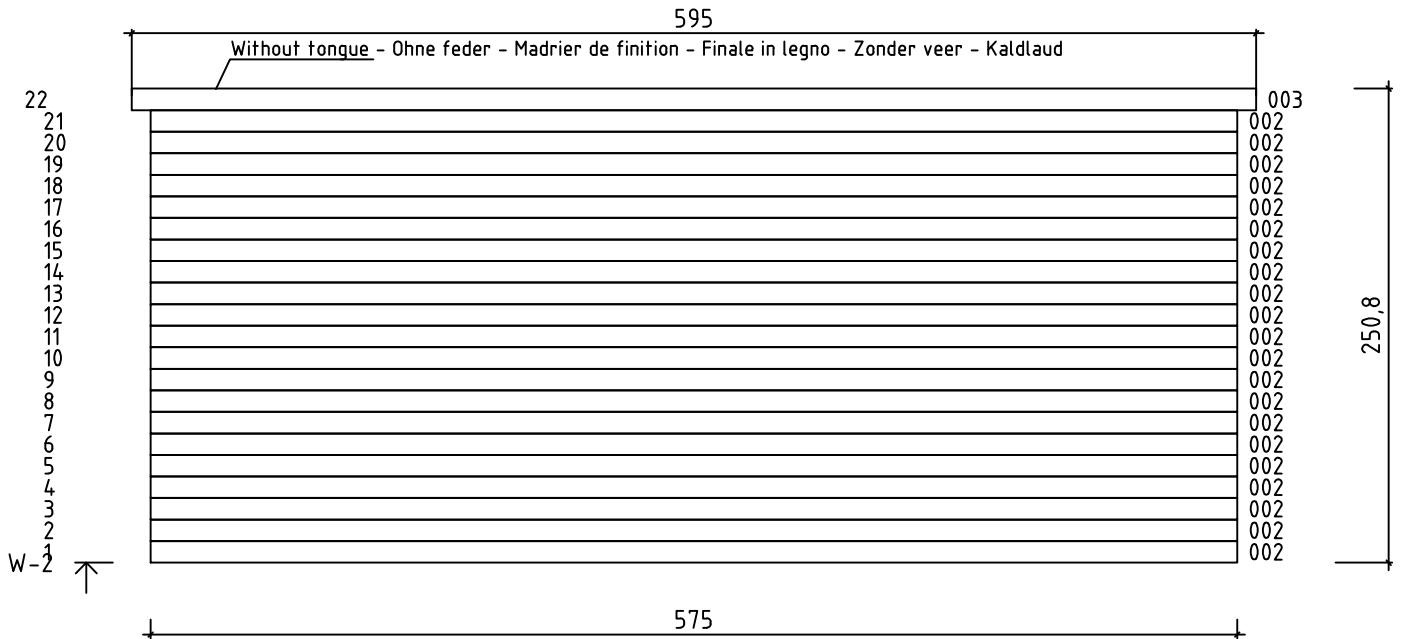
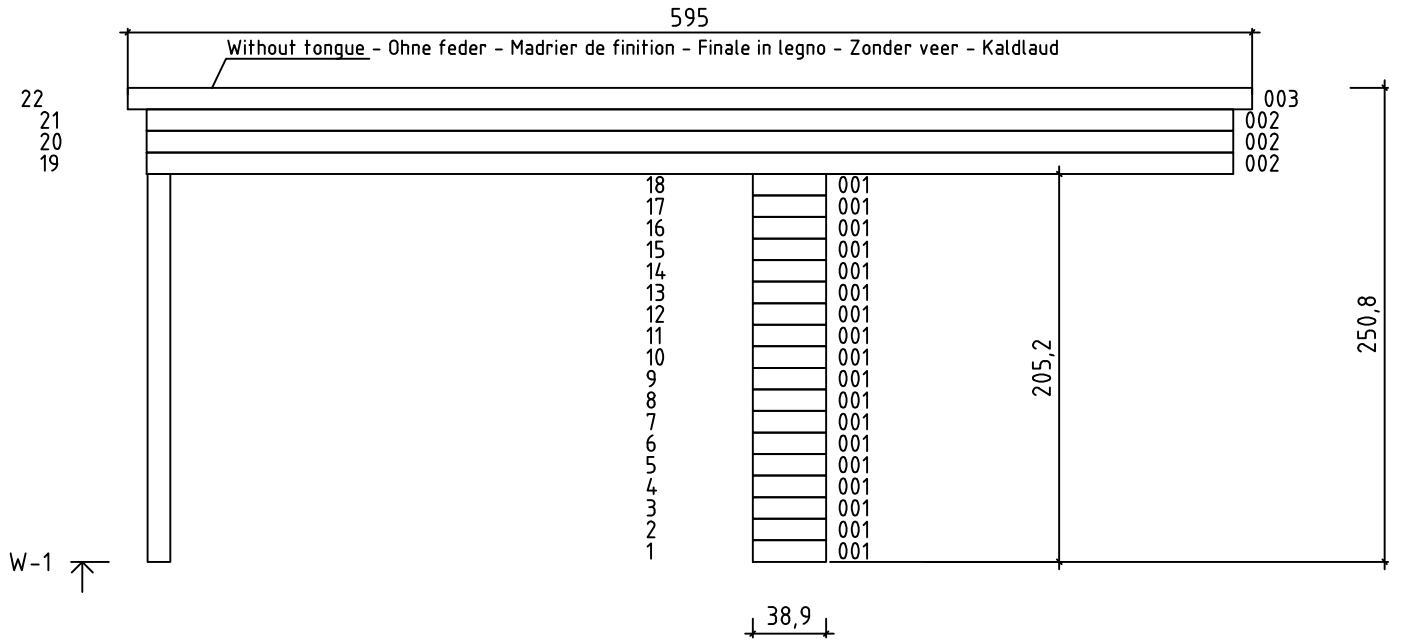



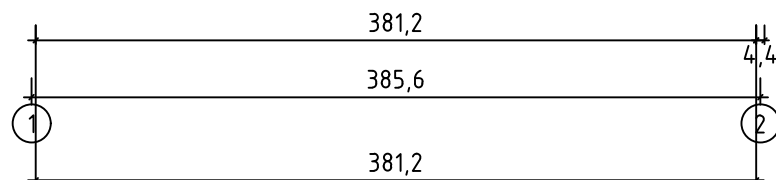
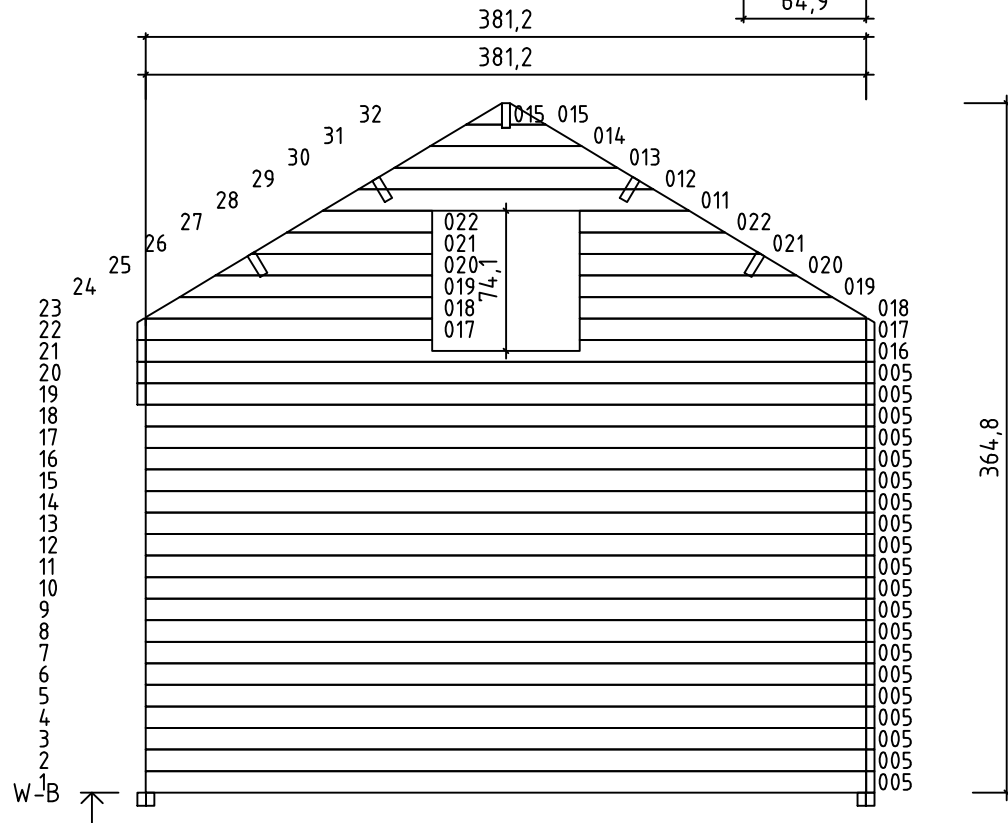
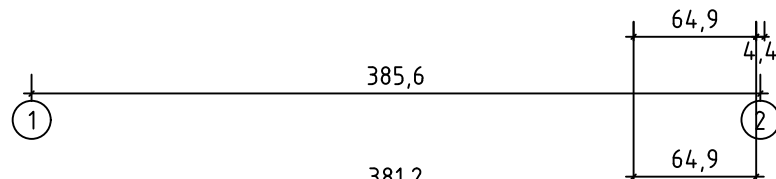
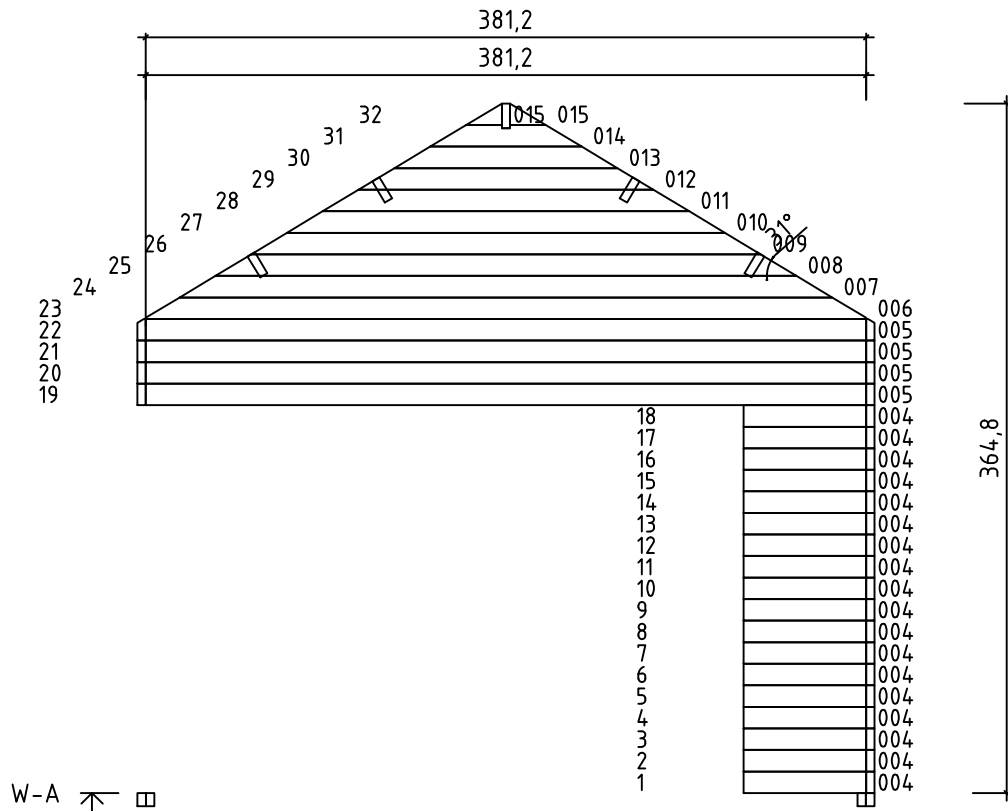

Art. Nr. 4428719

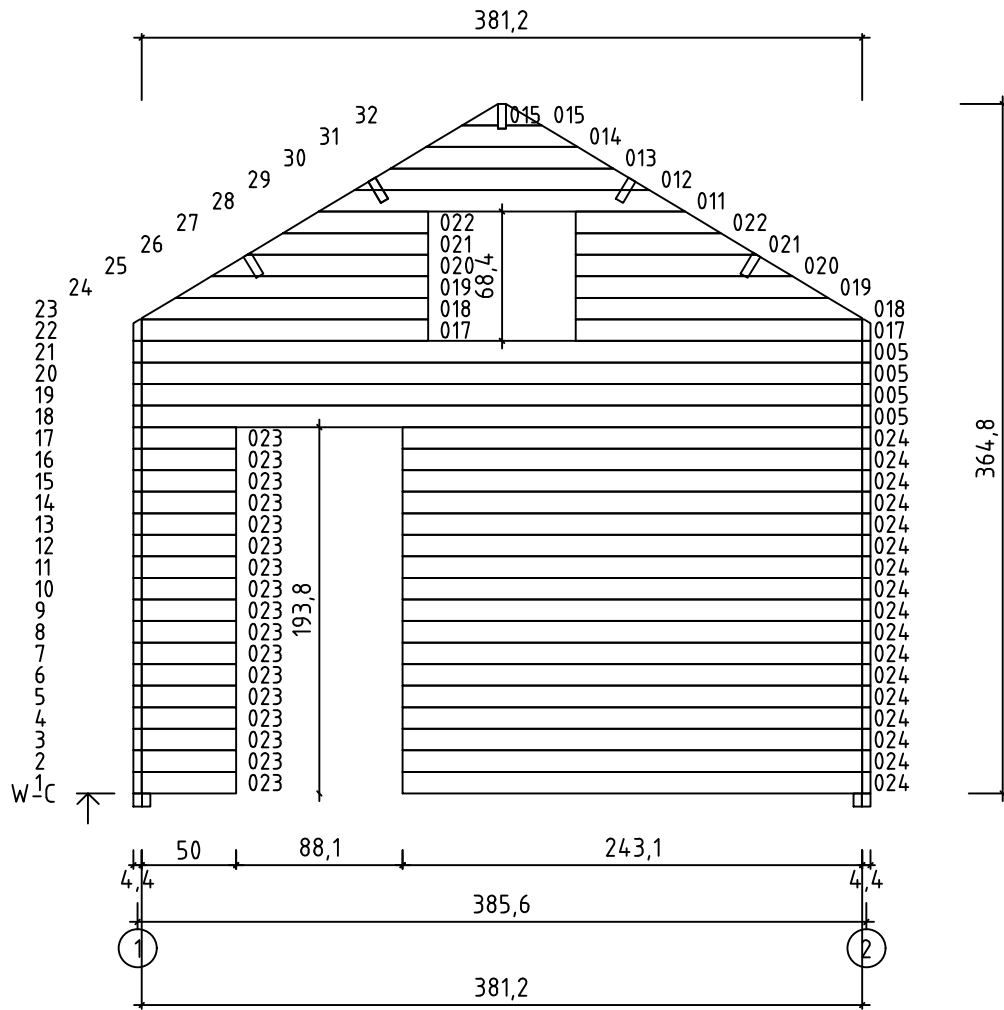

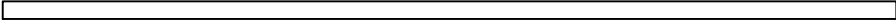
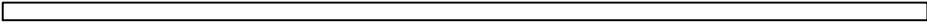
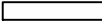
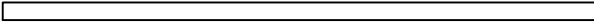
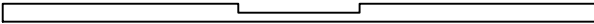
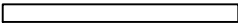

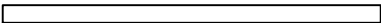
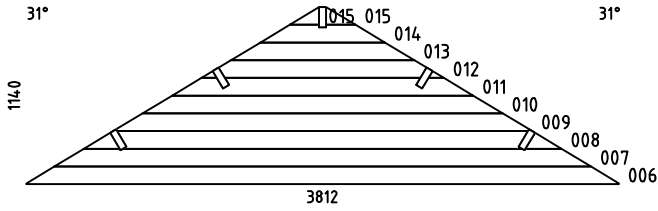
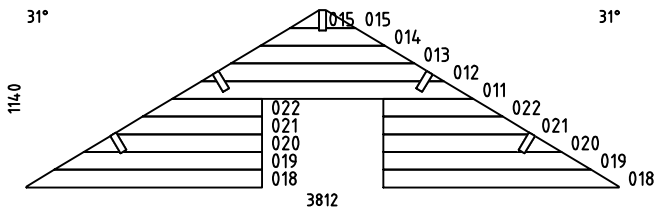
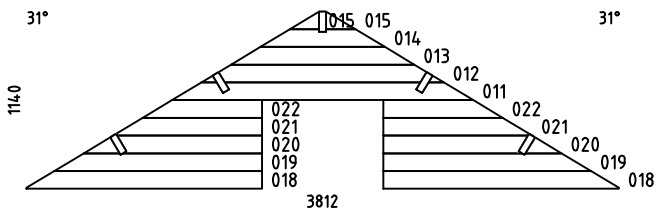
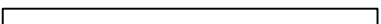

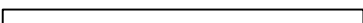
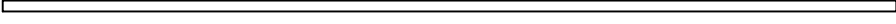
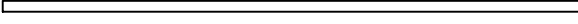





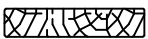
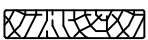

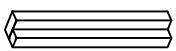

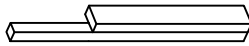

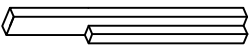

Art. Nr. 4428719

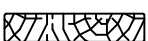





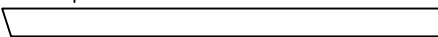

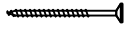
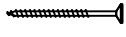
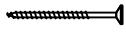

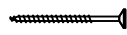
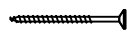
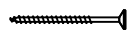

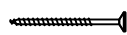

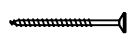
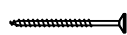

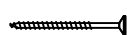
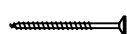

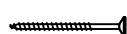
Pos	22.03.2023 Piece list - Stückliste - Liste des pièces - Elementi - Stuklijst - Tükítabel Art. Nr. 4428719 8/23	Q	P (mm)	L (mm)
001 44191		18	44x114	389
002 44190		24	44x114	5750
003 43493		2	44x114	5950
004 44194		18	44x114	649
005 44195		28	44x114	3812
016 45398		1	44x114	3812
017 45399		4	44x114	1516
023 28276		17	44x114	500
024 44196		17	44x114	2431
WA-1 44197		1		
WB-1 44198		1		
WC-1 44198		1		
B1 45400	Mezzanine floor joists - Halbgeschoss balken - Solives de plancher mezzanine - Travi del pavimento mezzanino - Plaatduim scharnier - Laetalad 	5	44x140	2411
B2 45401	Mezzanine floor joists - Halbgeschoss balken - Solives de plancher mezzanine - Travi del pavimento mezzanino - Plaatduim scharnier - Laetalad 	1	44x140	2367
B3 45402	Mezzanine floor joists - Halbgeschoss balken - Solives de plancher mezzanine - Travi del pavimento mezzanino - Plaatduim scharnier - Laetalad 	1	44x140	2321
IAR3 7672	Foundation - Fundament - Fondation - Fondamenta - Fundering - Immutatud alusraam 	4	45x70	5750
IAR1 44202	Foundation - Fundament - Fondation - Fondamenta - Fundering - Immutatud alusraam 	14	45x70	3720



Pos	22.03.2023 Piece list - Stückliste - Liste des pièces - Elementi - Stuklijst - Tükitalabel Art. Nr. 4428719 9/23	Q	P (mm)	L (mm)
IAR2 888	Foundation - Fundament - Fondation - Fondamenta - Fundering - Immutatud alusraam 	2	45x70	3690
RV1 45403	Lath - Pfetten - Liteau - Piccola asse - Gordingen - Roov 	1	44x44	3812
RV2 45404	Lath - Pfetten - Liteau - Piccola asse - Gordingen - Roov 	1	44x44	3678
A-PR1 44203	Roof beam - Dachbalken - Panne de toit - Perlina del tetto - Gordingen / dakbalk - Pärilin 	5	44x140	5950
FB-1 697	Floor boards - Fussbodenbretter - Lamé de plancher - Pavimento - Vloerhout - Pörandalaud 	27+1	90x18	3808
FB-2 44204	Floor boards - Fussbodenbretter - Lamé de plancher - Pavimento - Vloerhout - Pörandalaud 	43+1	90x18	3203
FB-3 44205	Floor boards - Fussbodenbretter - Lamé de plancher - Pavimento - Vloerhout - Pörandalaud 	43+1	90x18	2407
RB 2148	Roof boards - Dachbretter - Voliges - Perlina per tetto - Dakhout - Katuselaud 	134+2	90x18	2600
FL-1 30087	Floor fillet - Fussbodenleiste - Corniere de finition du plancher - Finitura per pavimento (battisco pa) - Vloerafwerklijst - Pörandaliist 		18x18	39
DPL-1 2150	Roofing felt fillet - Dachpappenleiste - Baguette de fixation du feutre bitumeux - Asse per fissaggio guaina bituminosa - Afdekljst asfaltpapier - Katusepapiiist 	4	18x58	2650
CM1 45409	Covering moulding - Deckungsprofil - Profils de finition verticaux a fixer a l'exterieur du cadre de la porte - Cornice di finitura - Afdek profiel - Lengipuu 	2	38x46	680
CM2	Covering moulding - Deckungsprofil - Profils de finition verticaux a fixer a l'exterieur du cadre de la porte - Cornice di finitura - Afdek profiel - Lengipuu 	2	38x46	736
CM3 37815	Covering moulding - Deckungsprofil - Profils de finition verticaux a fixer a l'exterieur du cadre de la porte - Cornice di finitura - Afdek profiel - Lengipuu 	1	38x46	1980
CM4 38464	Covering moulding - Deckungsprofil - Profils de finition verticaux a fixer a l'exterieur du cadre de la porte - Cornice di finitura - Afdek profiel - Lengipuu 	2	38x46	2998
CF1 44210	Corner fillet - Deckleiste - Profils de finition angles a l'exterieur - Massello d'angolo - (hoek)lijst - Nurgaliist 	2	15x45	230
CF2 22328	Corner fillet - Deckleiste - Profils de finition angles a l'exterieur - Massello d'angolo - (hoek)lijst - Nurgaliist 	2	15x45	2055
PL-1 45405	Railing strip - Begrenzungsleiste - Rembarde - Sbarra - Afscheidingslijst - Piirdelaud 	1	18x70	668
PL-2 45406	Railing strip - Begrenzungsleiste - Rembarde - Sbarra - Afscheidingslijst - Piirdelaud 	1	18x70	680
PL-3 45407	Railing strip - Begrenzungsleiste - Rembarde - Sbarra - Afscheidingslijst - Piirdelaud 	4	18x70	763
PL-4 35597	Railing strip - Begrenzungsleiste - Rembarde - Sbarra - Afscheidingslijst - Piirdelaud 	3	18x70	2000
PL-5 45408	Railing strip - Begrenzungsleiste - Rembarde - Sbarra - Afscheidingslijst - Piirdelaud 	2	18x90	858
PL-6 44211	Railing strip - Begrenzungsleiste - Rembarde - Sbarra - Afscheidingslijst - Piirdelaud 	1	18x90	2020
PL-7 37814	Railing strip - Begrenzungsleiste - Rembarde - Sbarra - Afscheidingslijst - Piirdelaud 	1	18x90	2126

Pos	Piece list - Stückliste - Liste des pièces - Elementi - Stuklijst - Tükítabel 22.03.2023 Art. Nr. 4428719 10/23	Q	P (mm)	L (mm)
PL-8 44212	Railing strip - Begrenzungsleiste - Rembarde - Sbarra - Afscheidingslijst - Piirdelaud 	2	18x90	3040
PL-9 37903	Railing strip - Begrenzungsleiste - Rembarde - Sbarra - Afscheidingslijst - Piirdelaud 	2	18x90	3150
P6 37786	Post - Pfosten - Poteau - Piede registrabile - Stijl - Post 	1	44x44	2500
P2 44207	Post - Pfosten - Poteau - Piede registrabile - Stijl - Post  	2	88x88	2052
P3 44209	Post - Pfosten - Poteau - Piede registrabile - Stijl - Post  	1	88x88	2500
P4 44208	Post - Pfosten - Poteau - Piede registrabile - Stijl - Post  	1	88x88	2500
P1 43507	Post - Pfosten - Poteau - Piede registrabile - Stijl - Post 	2	90x90	2500
P5 44206	Post - Pfosten - Poteau - Piede registrabile - Stijl - Post 	1	120x120	2570
TB-1 3241	Fascia board - Traufbrett - Bandeau de toit - Finitura lati tetto - Gevellijst - Räästalaud 	4	18x90	2975
DRV-1 3242	Roof edge reinforcement - Dachrandverstärkung - Corniere de renfort de bord de toit - Rinforzo x tetto - Dakrand versterking - Räästatugevdus 	4	28x34	2975
44236	Ladder - Leiter - Echelle - Scala a pioli - Ladder - Redel	1	44x120	2750
44237	Ladder - Leiter - Echelle - Scala a pioli - Ladder - Redel	1	44x120	2750
24653	Ladder - Leiter - Echelle - Scala a pioli - Ladder - Redel	9	28x120	542
FF1 44213	Fixing fillet - Fixierungsleiste - Profil de fixation - Massello di fissaggio - Bevestiging lijstwerk - Tenderliist 	2	18x44	670
FF2 39848	Fixing fillet - Fixierungsleiste - Profil de fixation - Massello di fissaggio - Bevestiging lijstwerk - Tenderliist 	2	18x44	1900
FF3 44214	Fixing fillet - Fixierungsleiste - Profil de fixation - Massello di fissaggio - Bevestiging lijstwerk - Tenderliist 	6	18x44	2026
UT-1 44233	U-profile - U-profils - Profile u - Profilo ad u - U-profiel - U-profiil 	2	35x70	690
UT-2 44234	U-profile - U-profils - Profile u - Profilo ad u - U-profiel - U-profiil 	1	35x70	790
GL-1 44215	Gable moulding - Giebelleiste - Planche de rive - Finitura per frontale e retro del tetto - Gevellijst - Viilulaud 	4	18x120	2650
HS8 5105	Screw for gable segment - Schrauben für deckblatt - Vis pour fixation losange de finition - Viti x frontali tetto - Schroef voor gevelpunt segment - Kruvi rombile 	4	3.5x35	
HS9 5106	Screw for u-profile - Schraube zur befestigung u-profils - Vis a tete fraisée pour profil u - Vite per profilo ad u - Schroef ter bevestiging u-profiel - Kruvi U-profiilile 	9	3.5x50	
HS9 5106	Screw for gable moulding - Schrauben für giebelleiste - Vis pour fixation planche de rive - Vite per fissare finiture davanti e dietro del tetto - Schroef voor gevellijst - Kruvi viilulauale 	32	3.5x50	
HS32 5107	Screw for door jamb - Schraube für türrahmen - Vis de fixation partie haute avec montants du cadre de porte - Viti x fissaggio montanti porte - Schroef voor deurkozijn - Kruvi ukse lengile 	12	4.5x25	

Pos	Piece list - Stückliste - Liste des pièces - Elementi - Stuklijst - Tükítabel 22.03.2023 Art. Nr. 4428719 11/23	Q	P (mm)	L (mm)
HS14 5111	Screw for stairs - Schraube für treppen - Vis pour escalier - Vite per le scale - Schroef voor trap - Kruvi trepile 	36	4.5x80	
HS12 5109	Screw for doorstep - Schrauben für swelle - Vis pour fixation barre de seuil - Vite per soglia della porta - Schroef voor deurdorpel - Kruvi lävepakule 	11	4x40	
HS12 5109	Screw for metal corner - Holzschraube für metallwinkel - Vis de fixation des cornieres en métal - Viti per fissare suadretta di metallo di giunzione - Schroef voor metalen hoek - Kruvi nurgikule 	20	4x40	
HS12 5109	Screw for covering moulding - Schrauben für deckungsprofil - Vis de fixation profils horizontaux haut inférieur et extérieur d'encadrement de porte - Vite per cornice di copertura - Schroef voor afdekprofiel - Kruvi piirdelauale 	96	4x40	
HS12 5109	Screw for covering moulding - Schrauben für deckungsprofil - Vis de fixation profils horizontaux haut inférieur et extérieur d'encadrement de porte - Vite per cornice di copertura - Schroef voor afdekprofiel - Kruvi piirdelauale 	14	4x40	
HS12 5109	Screw for universal hook - Schrauben für universalhaken - Vis pour crochets universels - Vite per gancio universale - Schroef voor universele haak - Kruvi redeli fiksaatorile 	4	4x40	
HS12 5109	Screw for fascia boards - Schrauben für traufbretter - Vis pour fixation bandeau de toit - Viti x striscia del tetto - Schroef voor gevellijst - Kruvi räästalaualle 	28	4x40	
HS12 5109	Screw for roof edge reinforcement - Schrauben für dachrandverstärkung - Vis pour fixation corniere renfort de bord de toit - Viti x rinforzo bordo tetto - Schroef voor dakrand versterking - Kruvi räästatugevdusele 	28	4x40	
HS12 5109	Screw for fixing fillet of door and window - Schrauben für fixierungsleiste - Vis pour profil vertical de fixation pour ouvertures des fenestres et portes - Viti per massello di fissaggio - Schroeven voor bevestiging van deur en raam lijsten - Kruvi tenderliistudele 	46	4x40	
HS12 5109	Screw for door jamb - Schraube für türrahmen - Vis de fixation partie haute avec montants du cadre de porte - Viti x fissaggio montanti porte - Schroef voor deurkozijn - Kruvi ukse lengile 	15	4x40	
HS18 5113	Screw for post - Schrauben für pfosten - Vis de fixation des poteaux - Viti per inviare - Schroef voor stijlen - Kruvi postile 	8	5x120	
HS18 5113	Screw for roof beams - Schrauben für dachbalken - Vis pour fixation pannes de toit - Viti per perline del tetto - Schroef voor gordingen / dakbalken - Kruvi pärlinitele 	15	5x120	
HS18 5113	Screw for gable - Schrauben für giebel - Vis pour fixation des pignons - Viti per timpano - Schroef voor gevelpunt - Kruvi viilude kinnitamiseks 	6	5x120	
HS33 5112	Screw for door jamb - Schraube für türrahmen - Vis de fixation partie haute avec montants du cadre de porte - Viti x fissaggio montanti porte - Schroef voor deurkozijn - Kruvi ukse lengile 	32	5x40	
HS34 40958	Screw for wall details - Schraube für wand details - Vis pour mur details - Viti per elementi della porta - Schroef voor wand details - Kruvi seinte montaažiks 	450	5x80	
HS16 5115	Screw for window jamb - Schraube für fenesterrahmen - Vis de fixation pour montant de fenetre - Viti per finestra ad oblo - Schroef voor vensterbank - Kruvi akna lengile 	4	5x90	
HS16 5115	Screw for foundation - Schrauben zur befestigung fundament - Vis de fixations des poutrelles de fondations - Viti x fundamenta - Schroef voor fundering - Kruvi alusraamile 	30	5x90	
HS16 5115	Screw for foundation - Schrauben zur befestigung fundament - Vis de fixations des poutrelles de fondations - Viti x fundamenta - Schroef voor fundering - Kruvi alusraamile 	22	5x90	
HS16 5115	Screw for door jamb - Schraube für türrahmen - Vis de fixation partie haute avec montants du cadre de porte - Viti x fissaggio montanti porte - Schroef voor deurkozijn - Kruvi ukse lengile 	24	5x90	
HS22 5120	Screw for 1. wall beam - Schraube für 1. bohlenreihe - Vis de fixations 1ere rangée de madriers avec poutrelles de fondations - Vite fissaggio alle fondamenta - Schroef voor 1 wandbalk - Kruvi poollauale 	18	6x150	
HS23 5121	Screw for wall details - Schraube für wand details - Vis pour mur details - Viti per elementi della porta - Schroef voor wand details - Kruvi seinadetailidele 	260	6x180	
HS21 5119	Screw for beam - Schrauben zur befestigung dachsparren - Vis pour solive - Viti per perline - Schroef voor balk (gording) - Kruvi talale 	50	6x80	
NF2 5127	Zn nail for floor fillet - Zn nagel für fussbodenleiste - Pointe pour corniere de finition du plancher - Chiodi x fissaggio pavimento - Spijker(nagel) voor vloer afdeklijst - Nael põrandaliistule 	80	1.4x40	



Art. Nr. 4428719

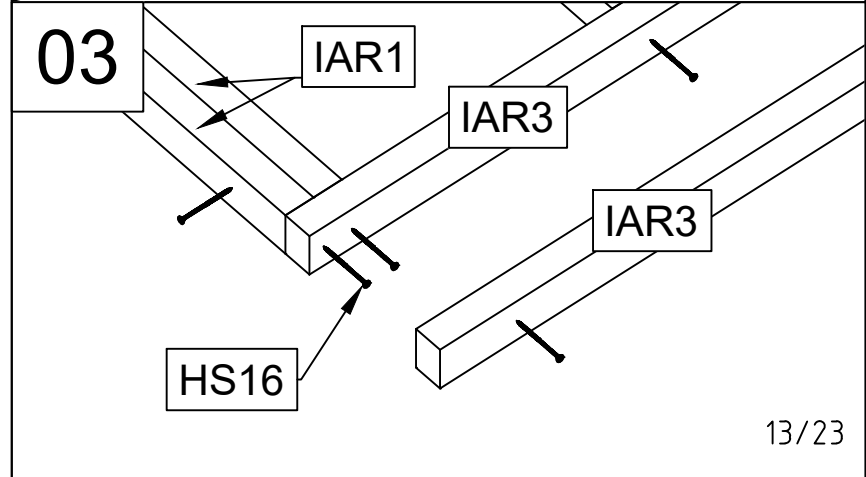
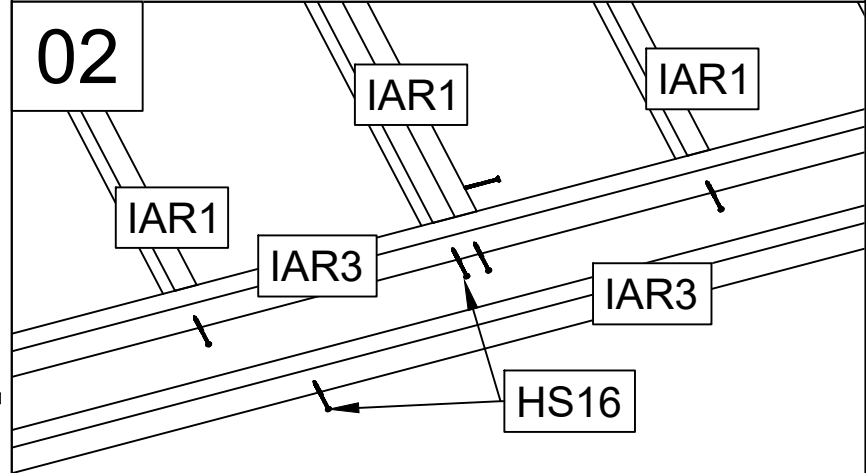
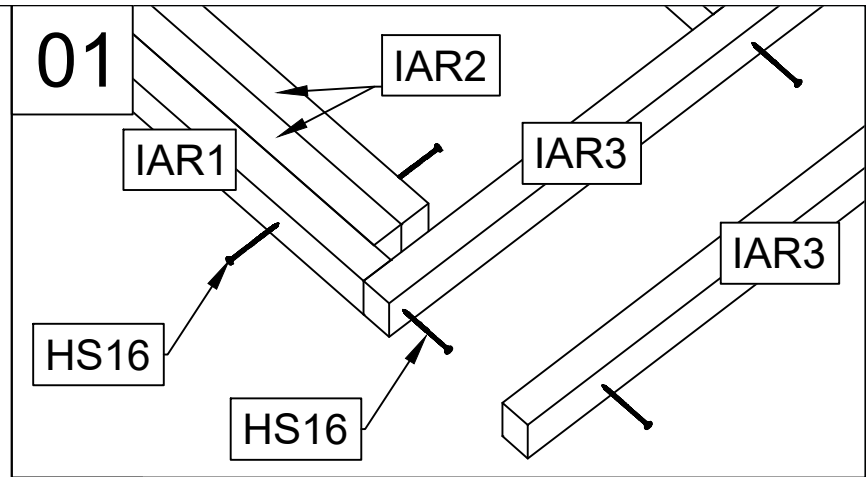
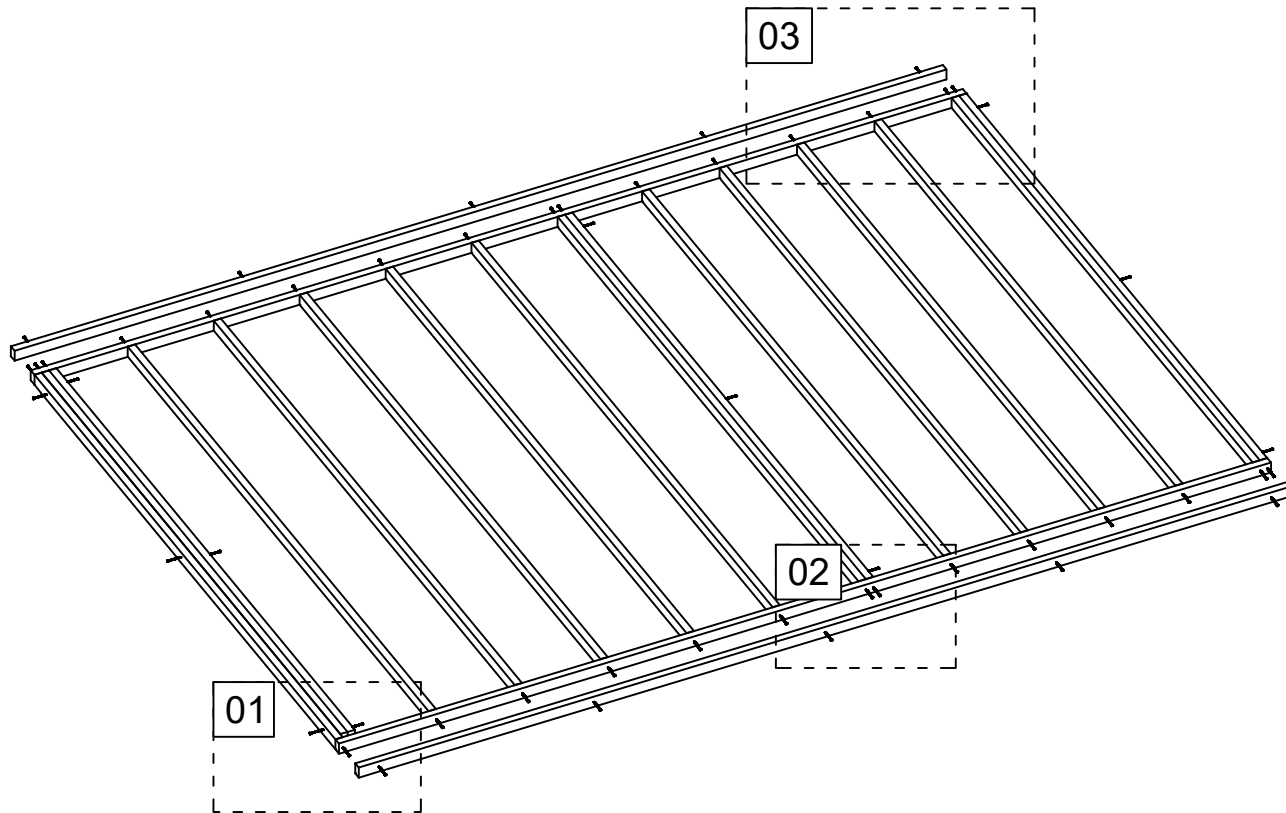

Art. Nr. 4428719

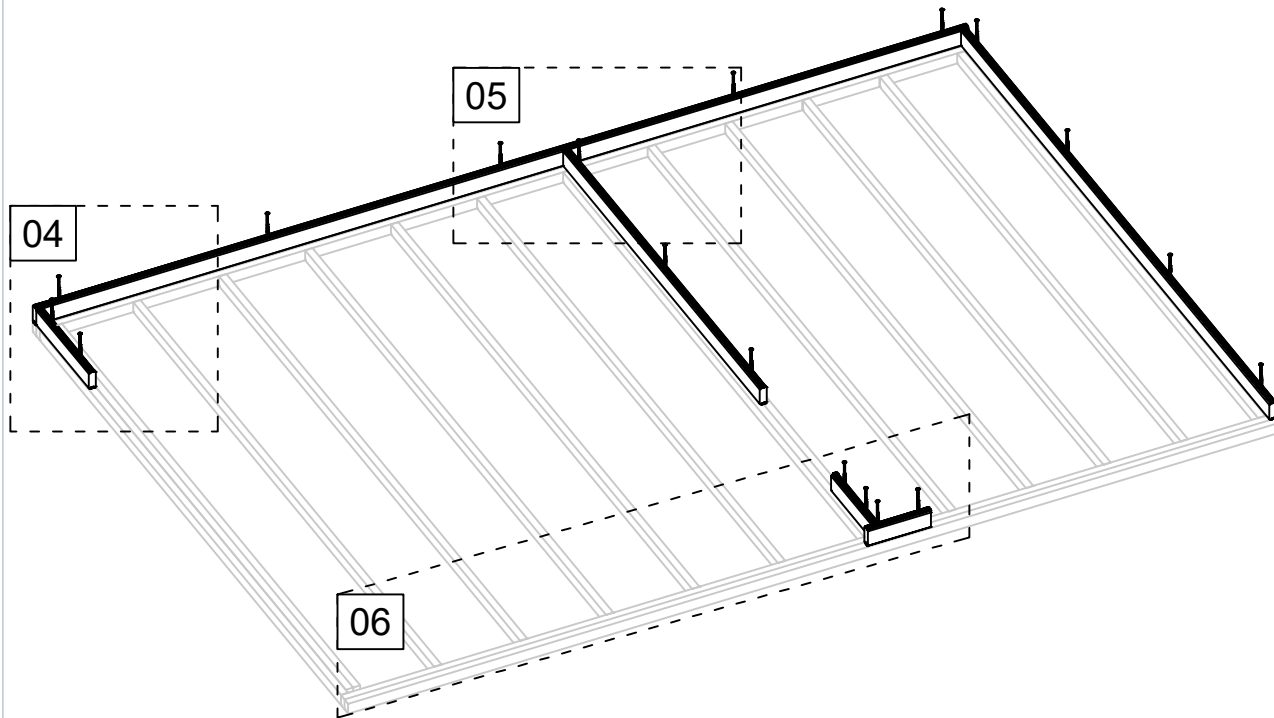

04

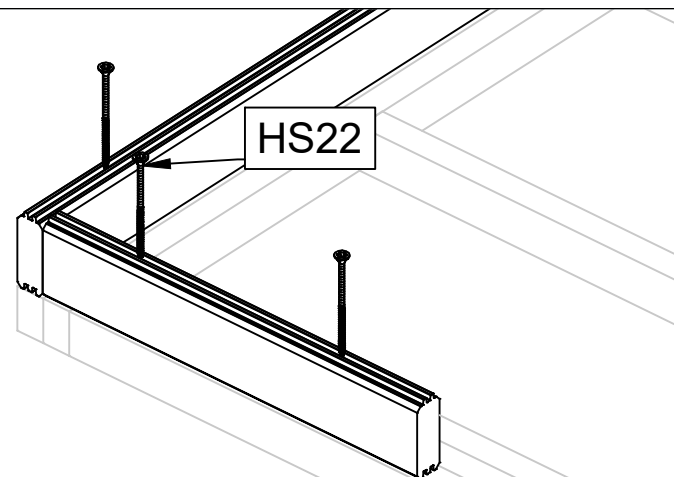

05

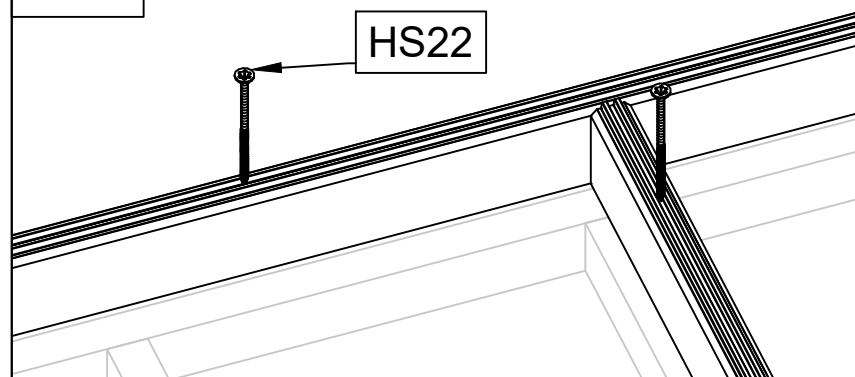

06

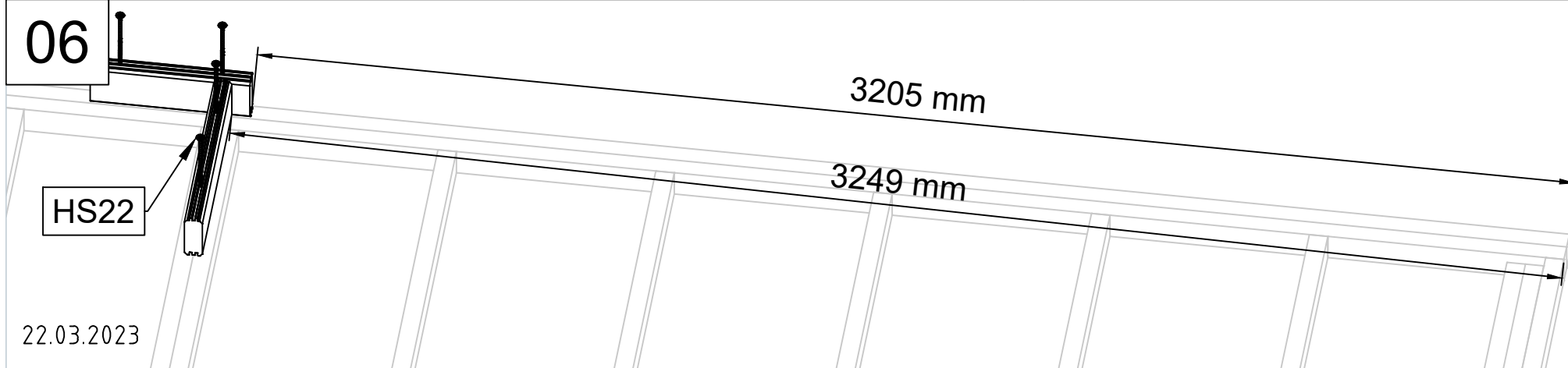

22.03.2023

14/23

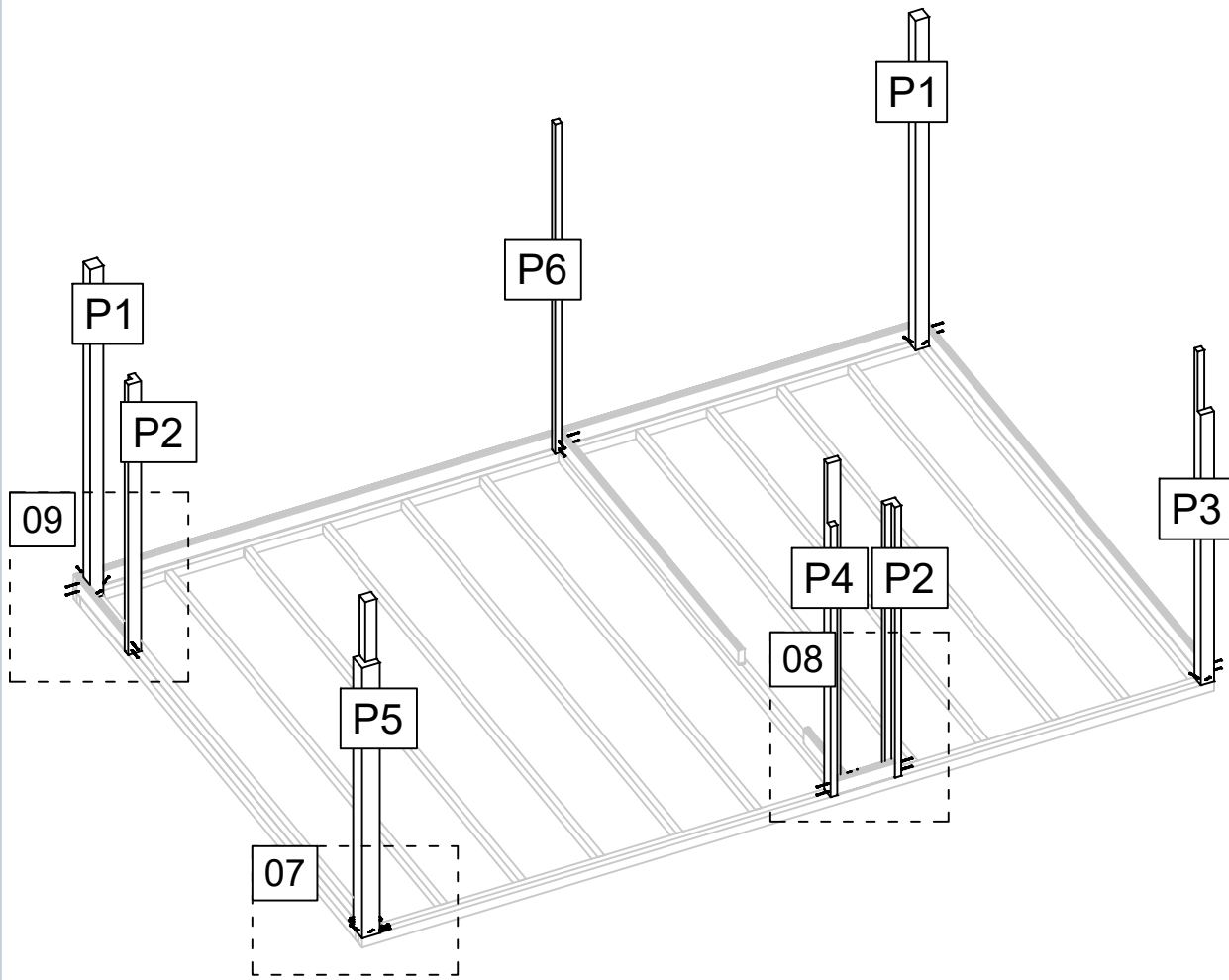

07

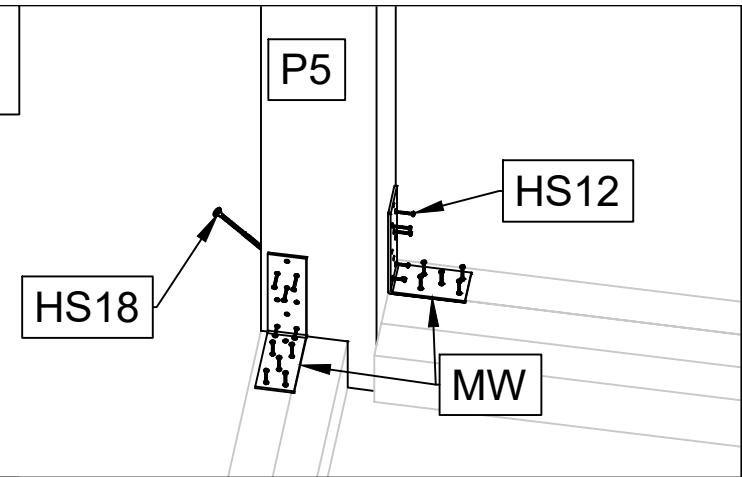

08

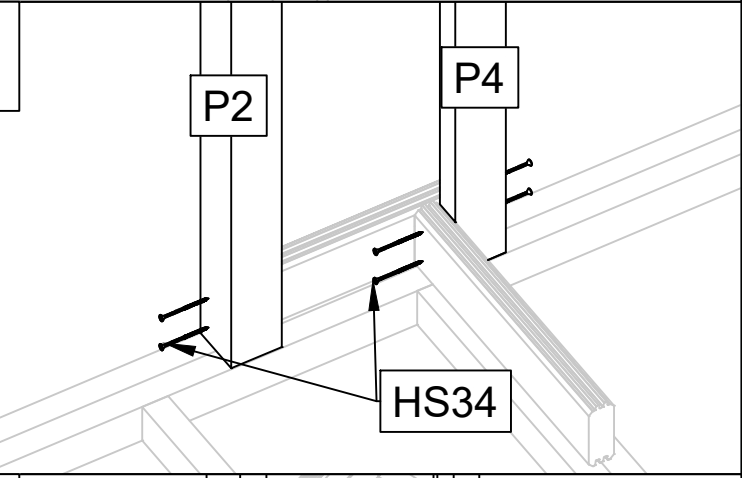

09

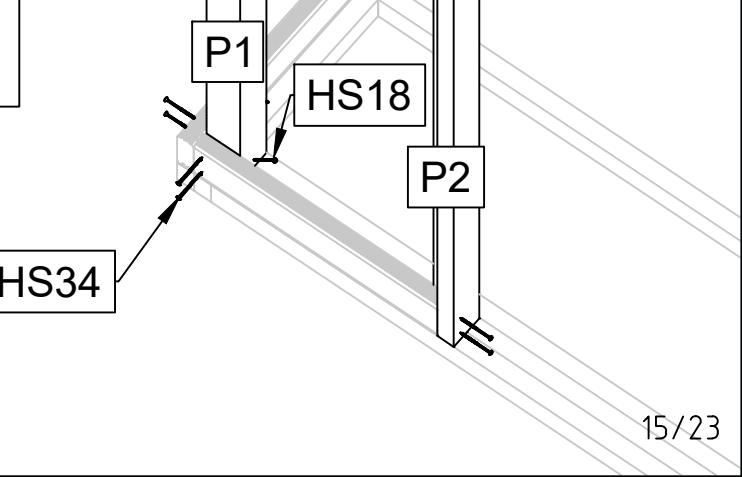

Art. Nr. 4428719

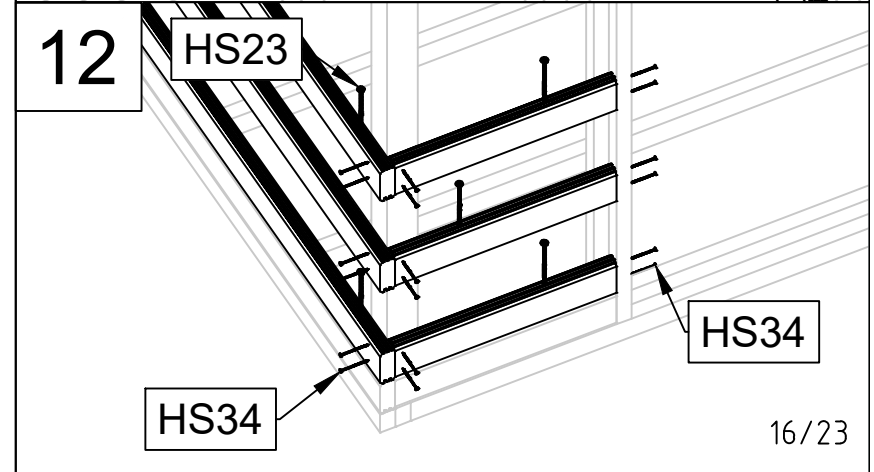
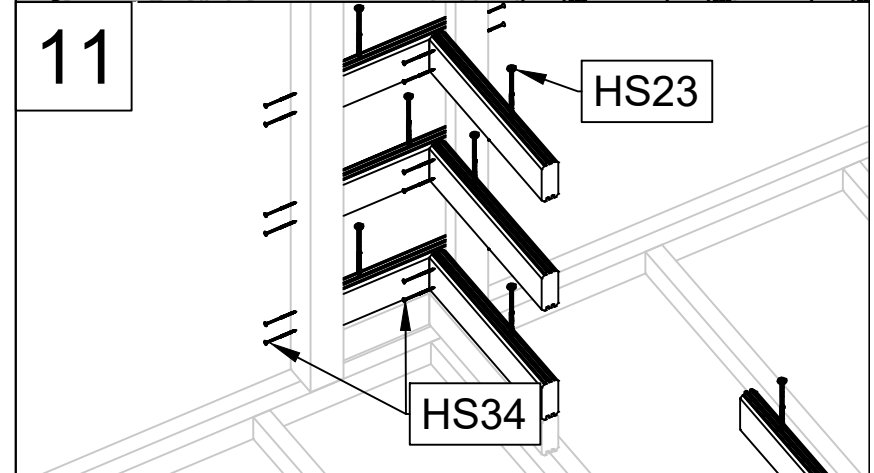
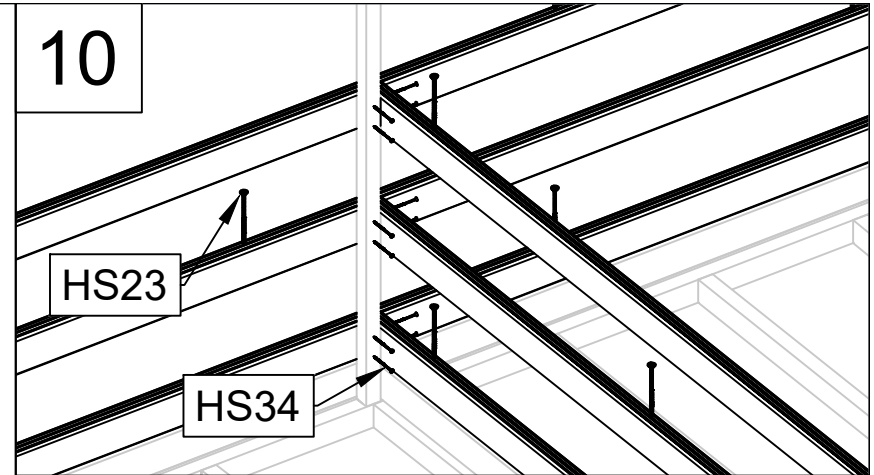
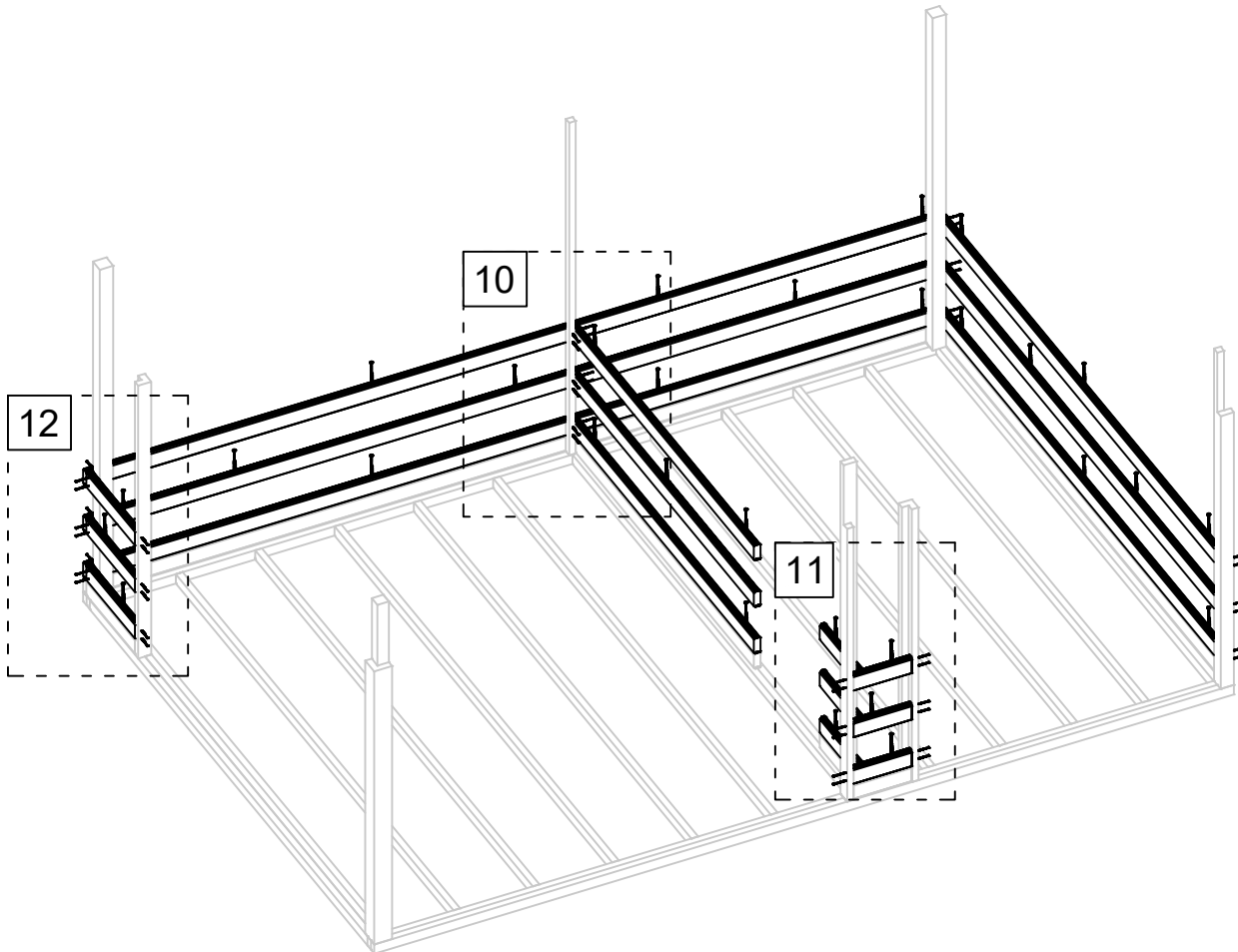



Art. Nr. 4428719

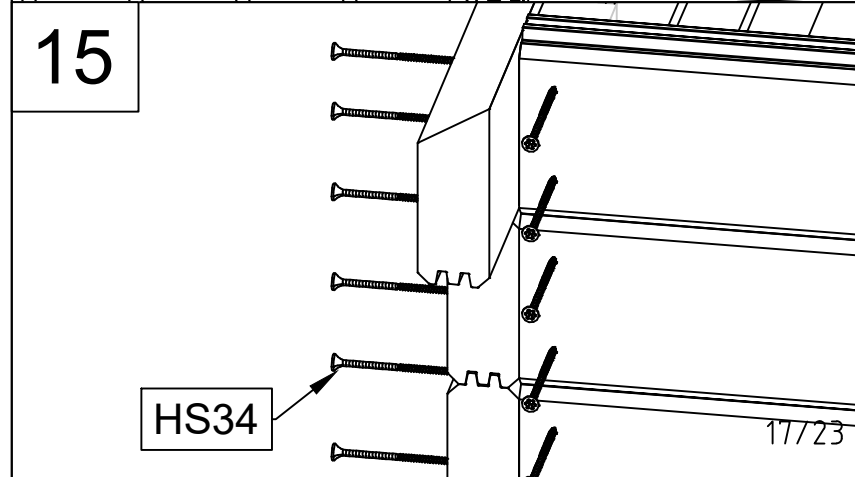
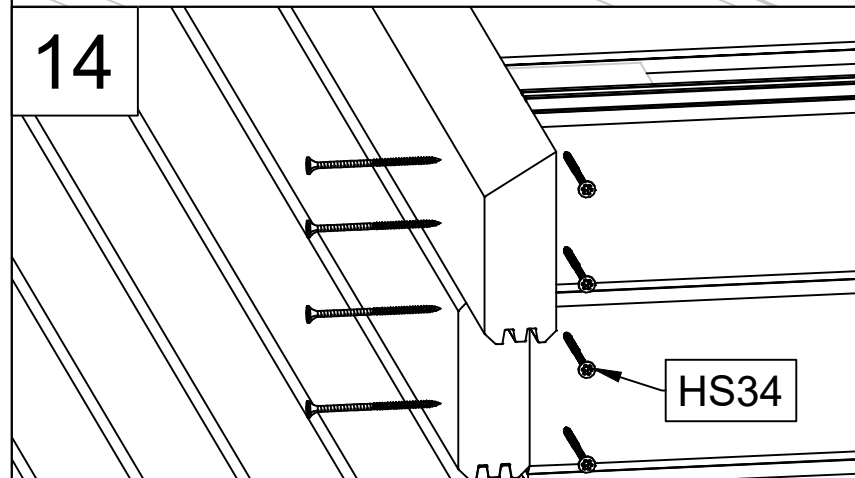
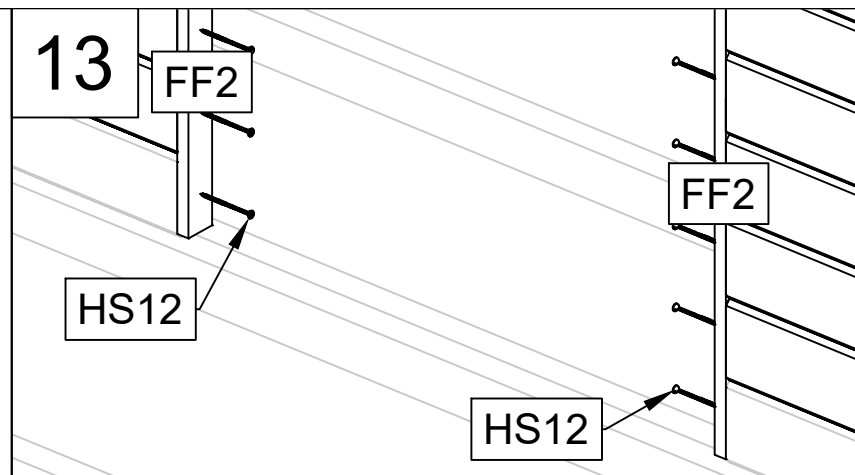
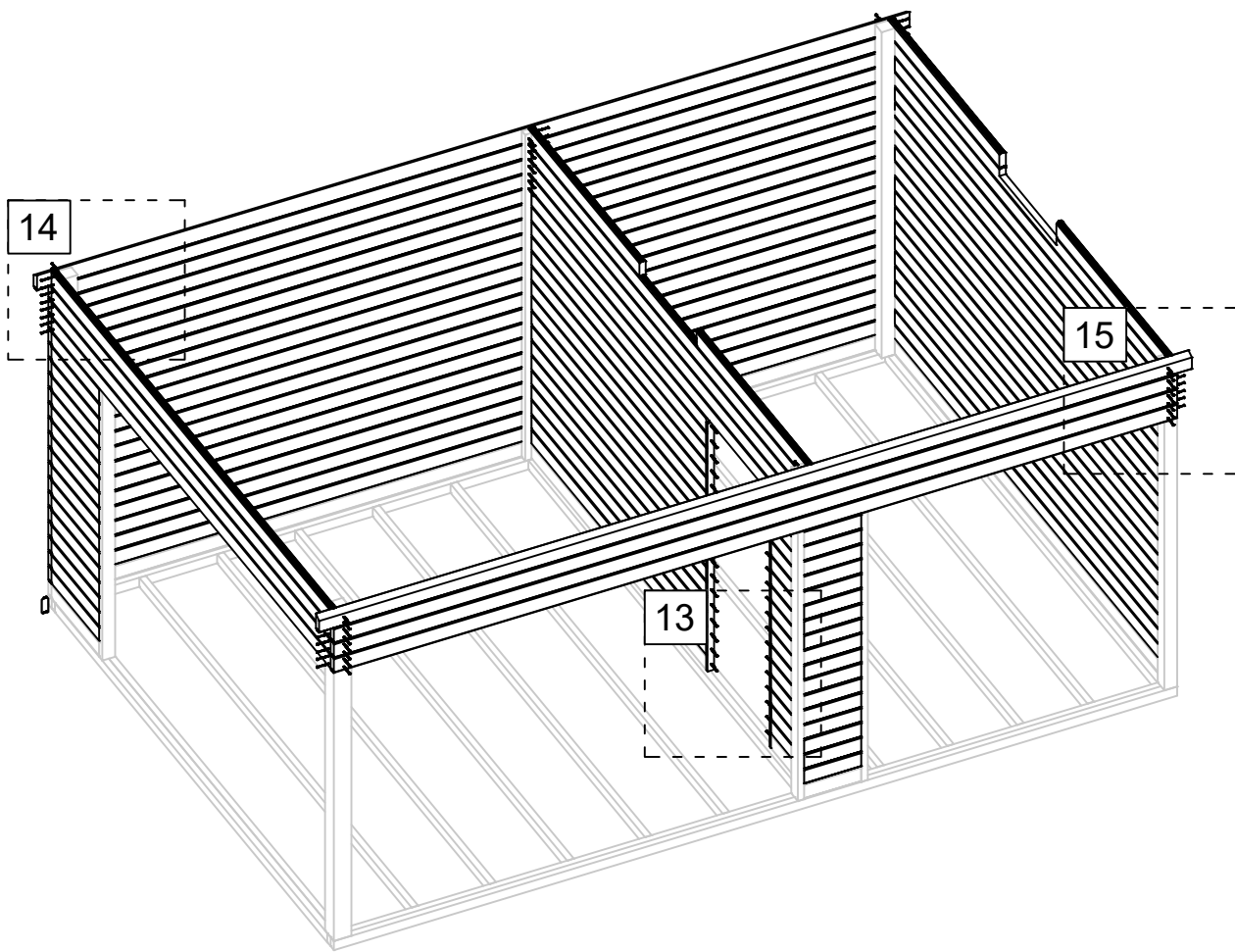

Art. Nr. 4428719

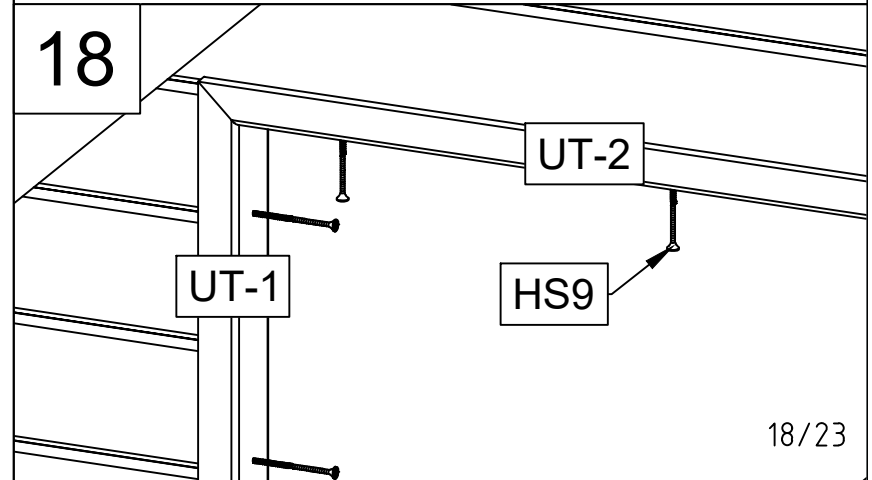
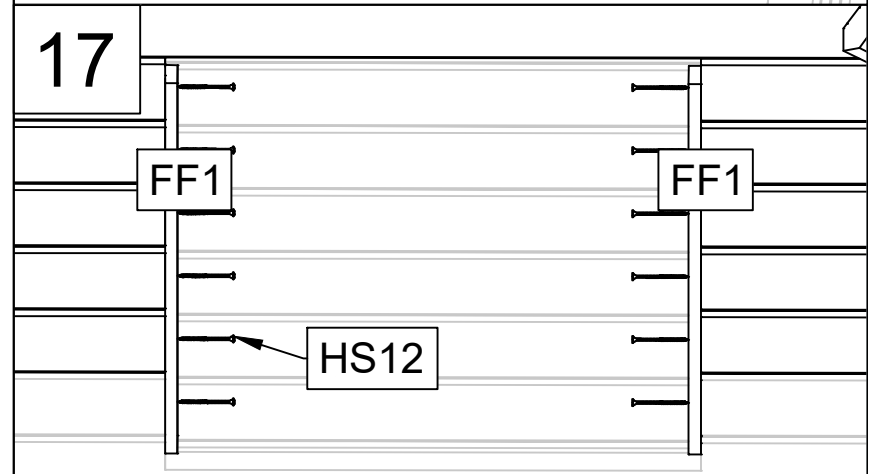
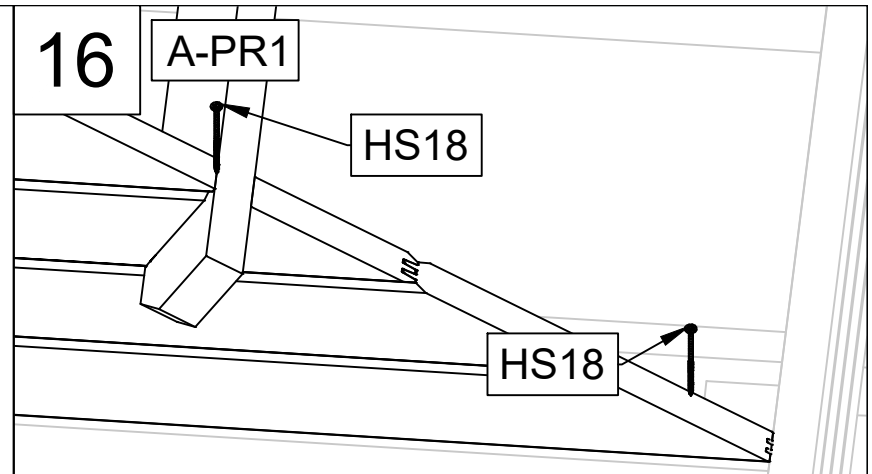
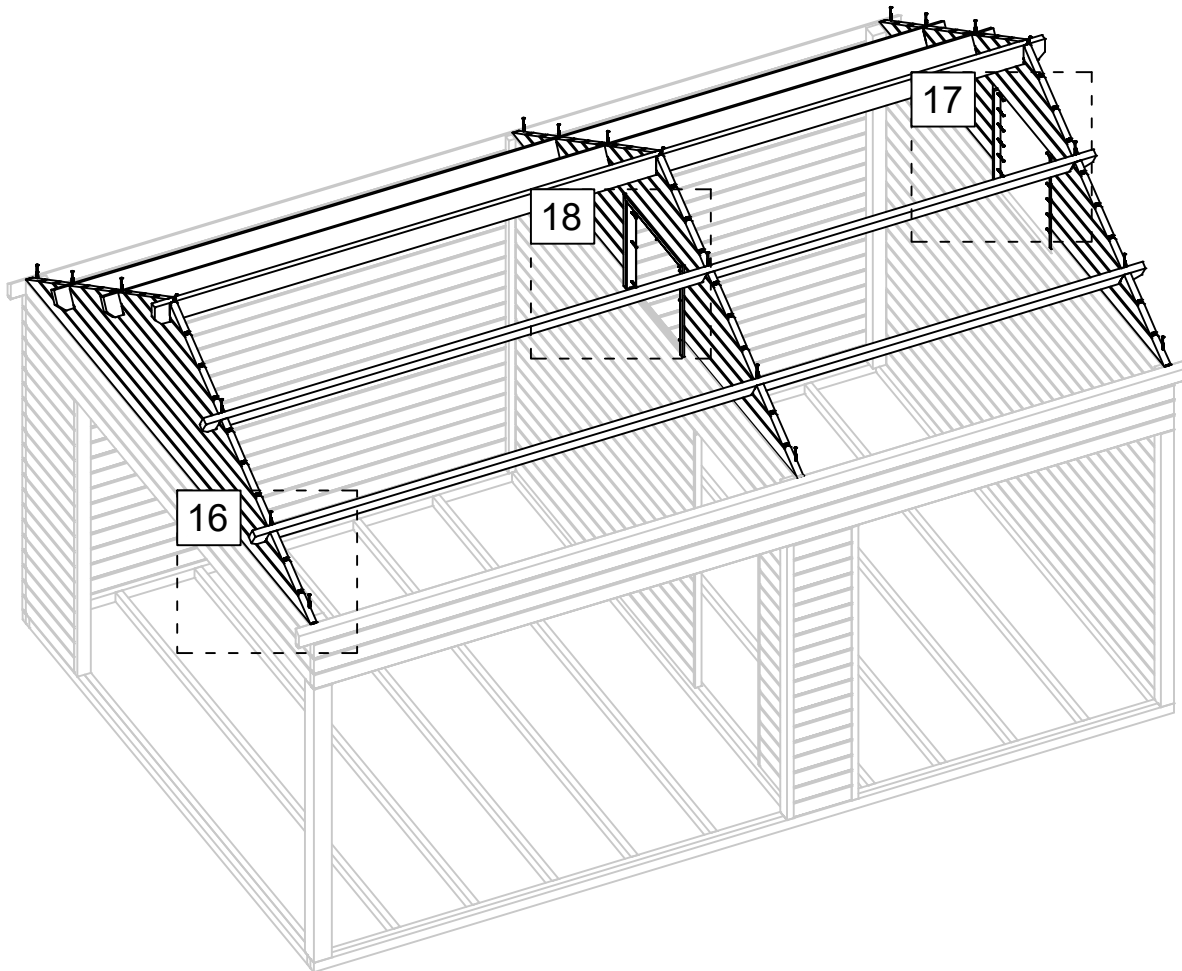

Art. Nr. 4428719

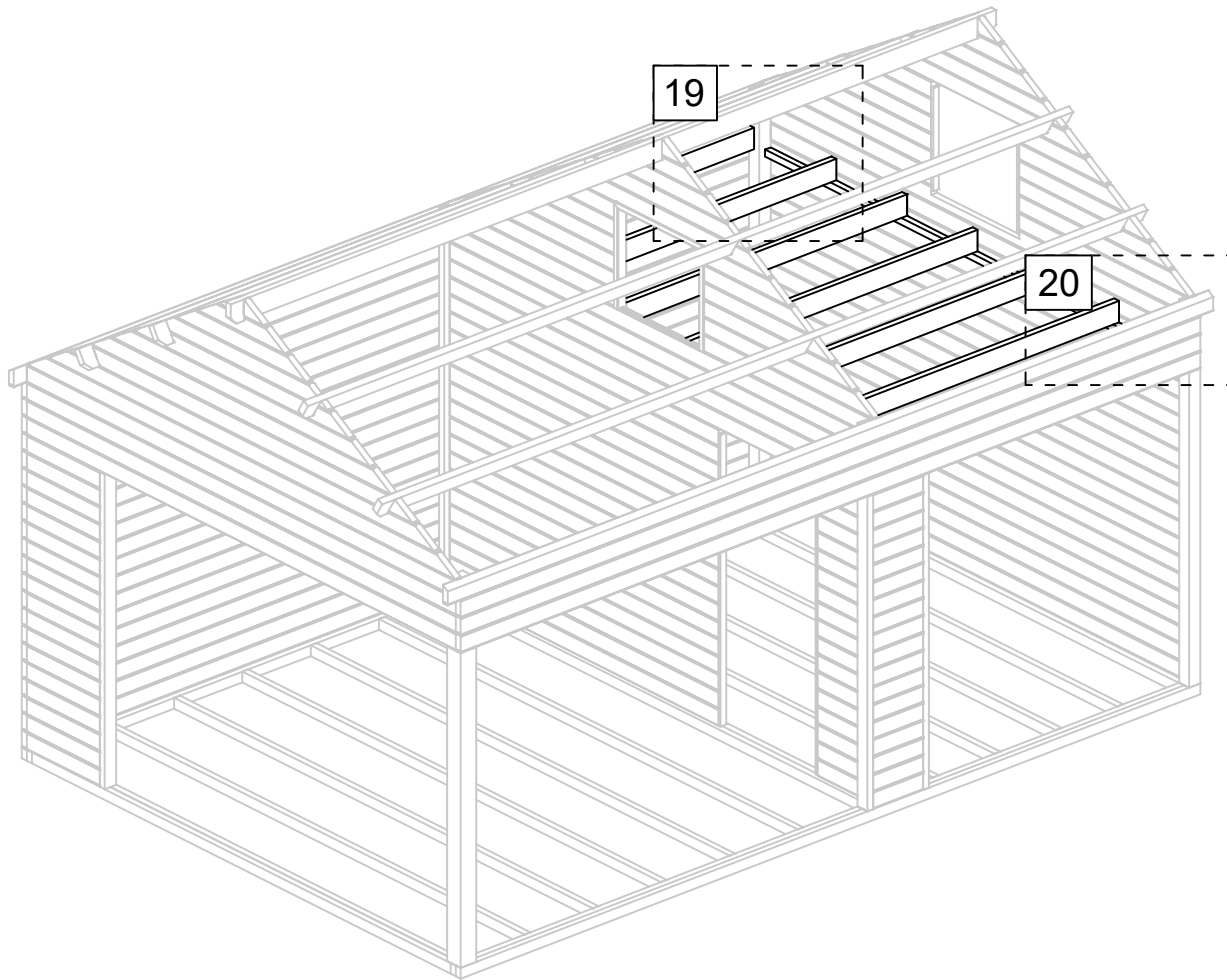

19

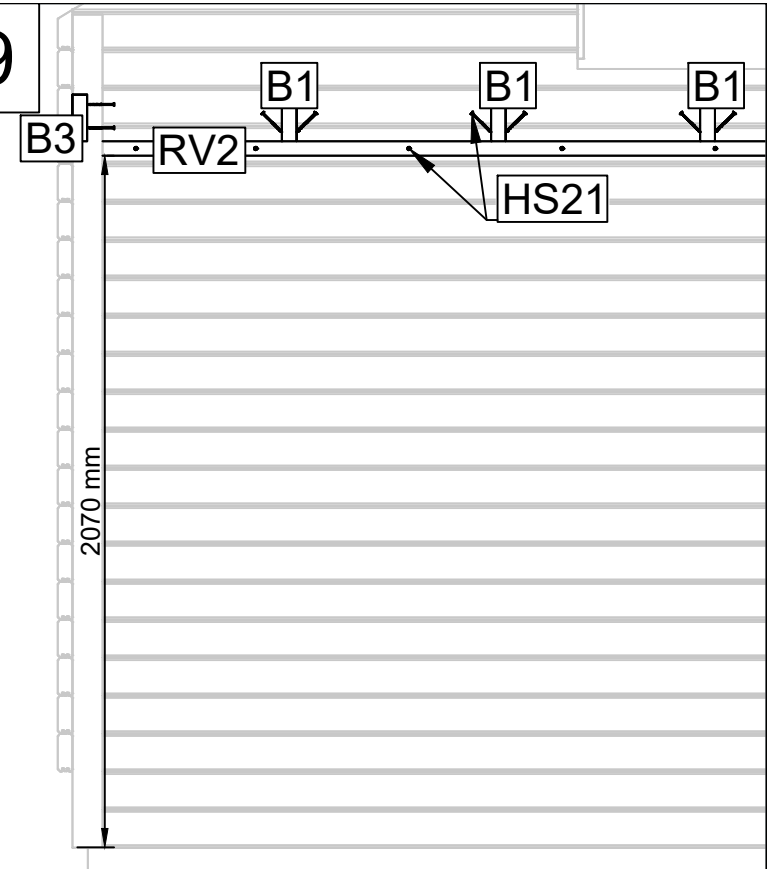

20

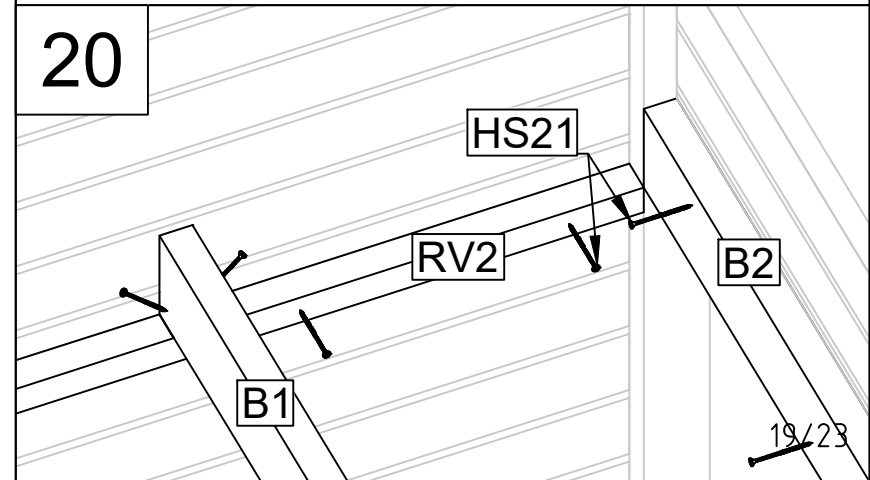

22.03.2023

19/23

Art. Nr. 4428719

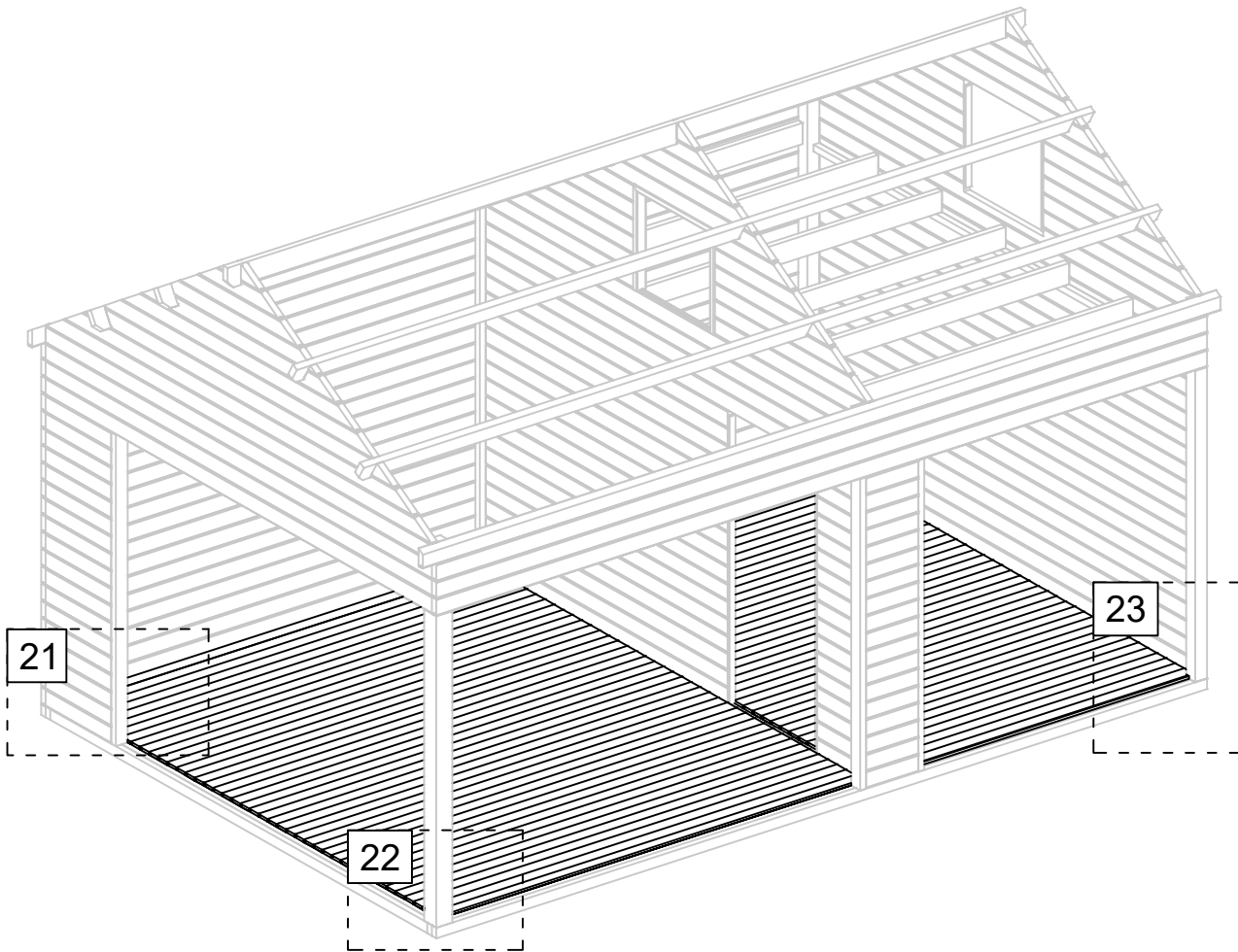

21

22

23

22.03.2021

21

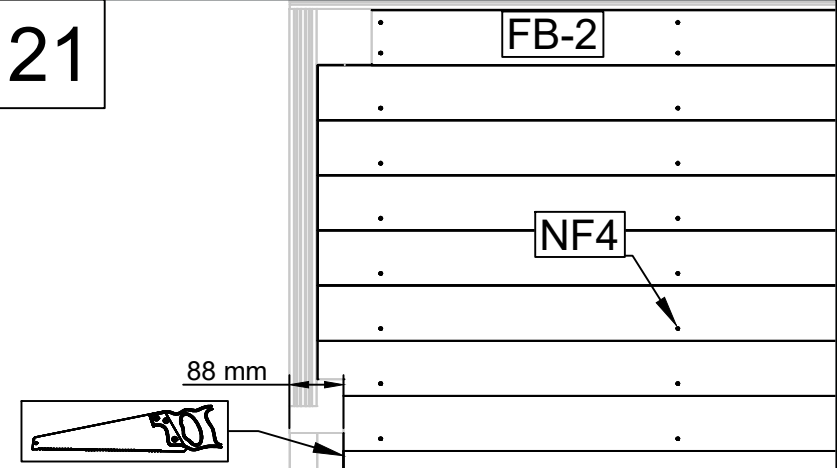

22

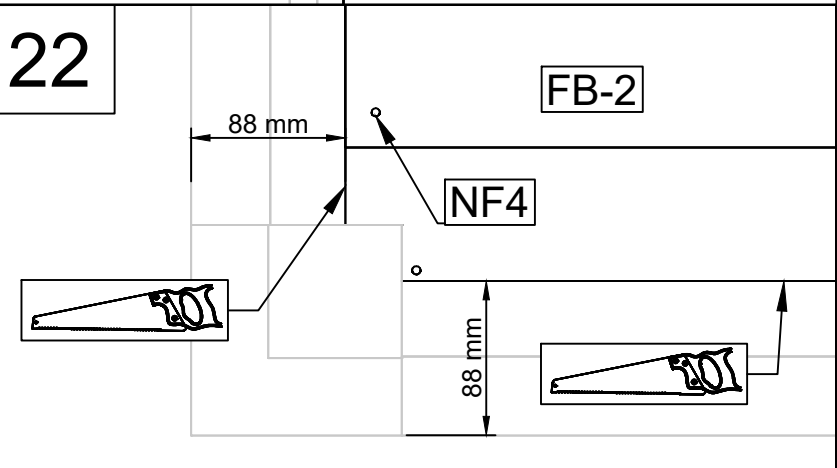

23

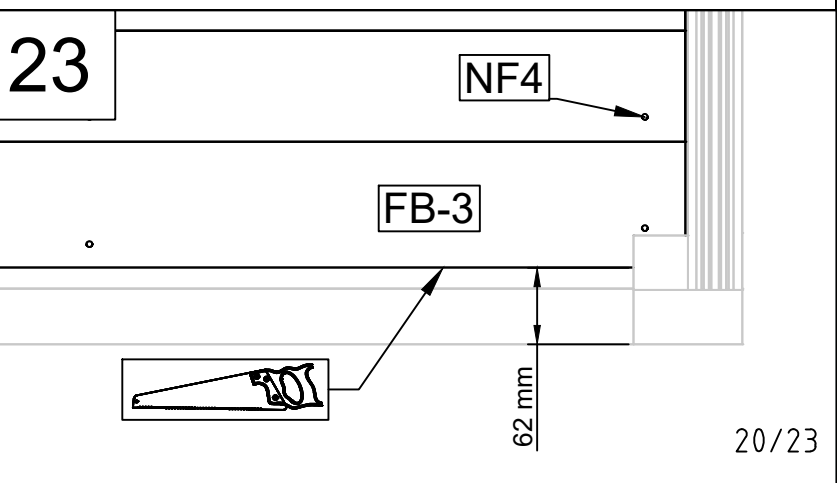

20/23

Art. Nr. 4428719

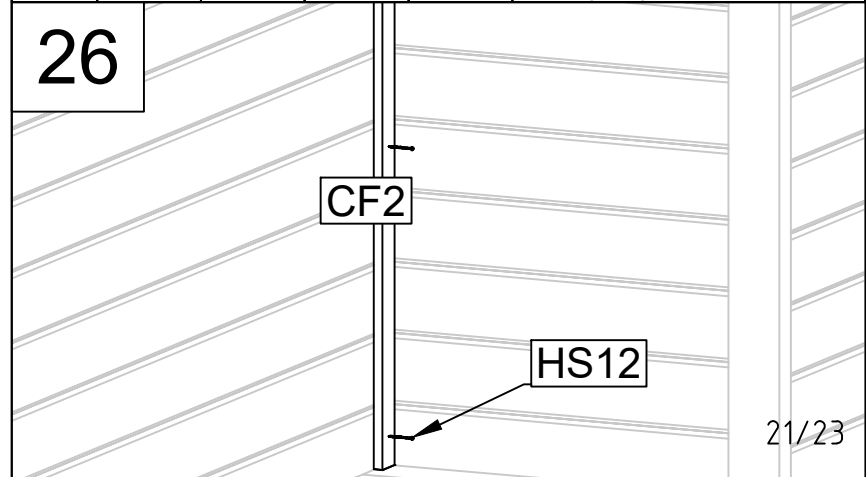
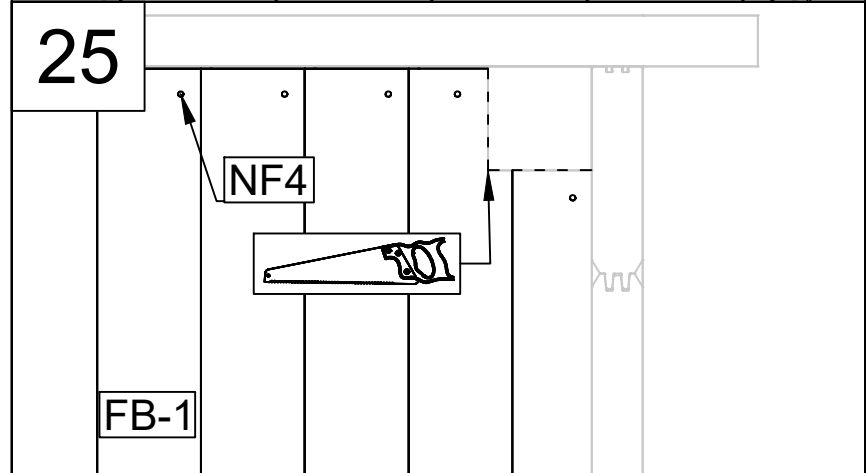
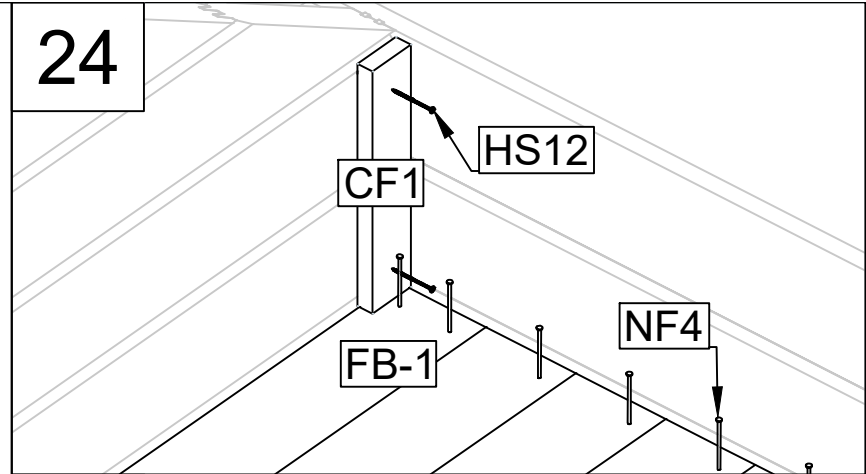
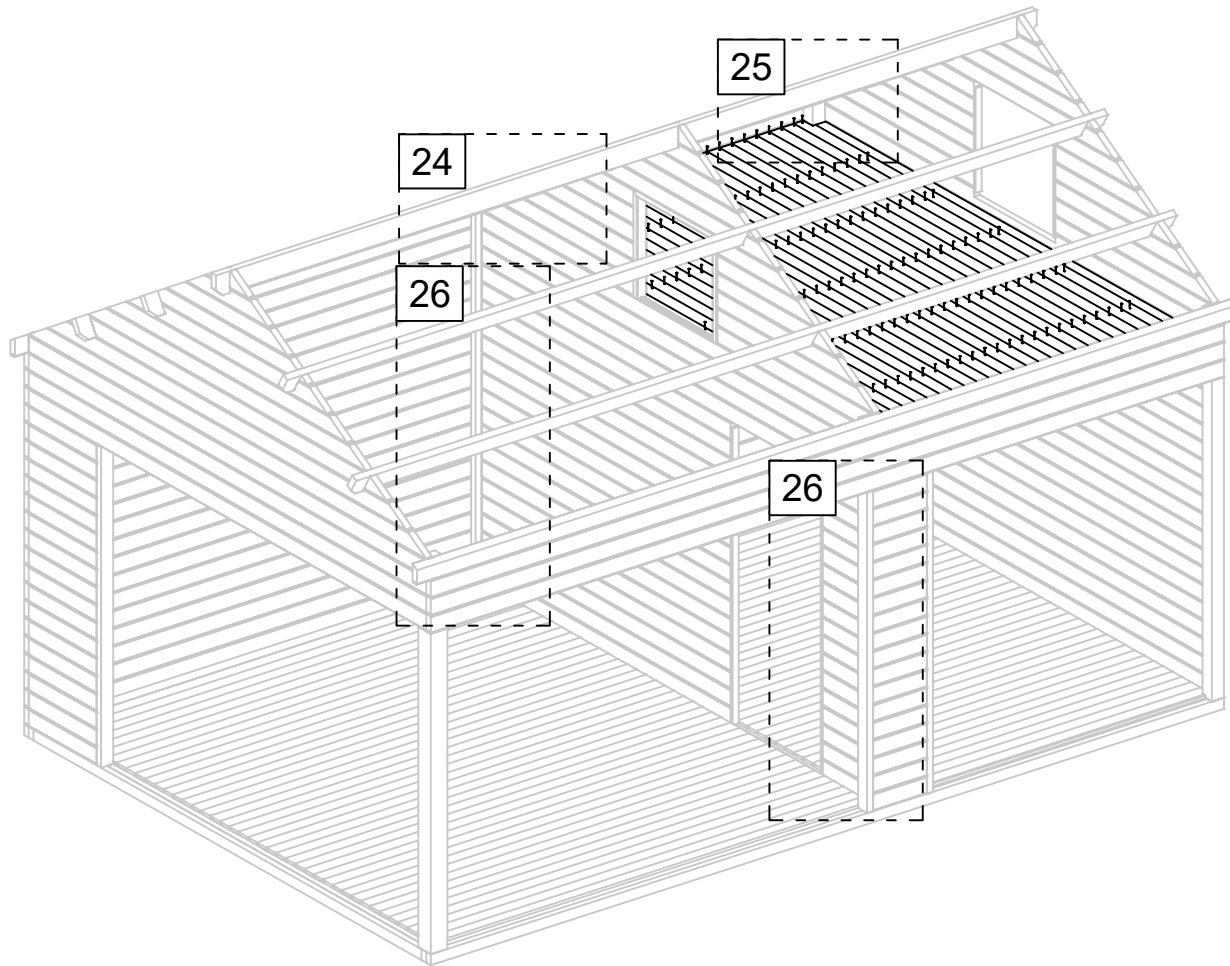

Art. Nr. 4428719

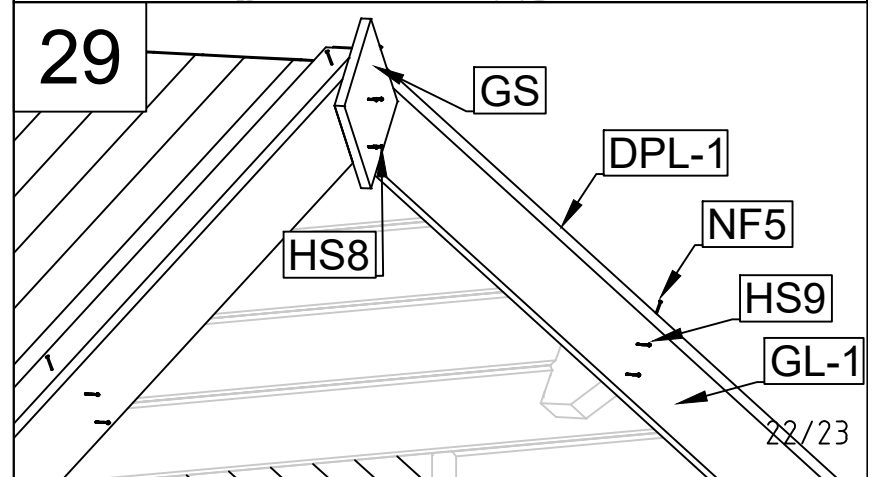
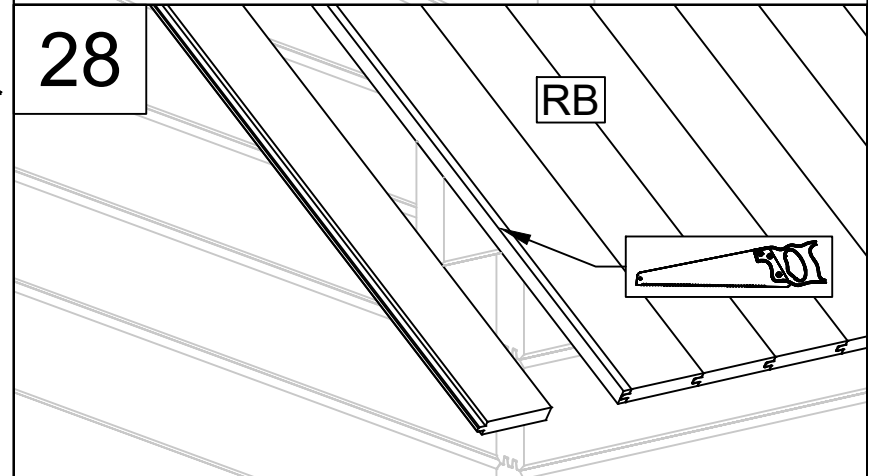
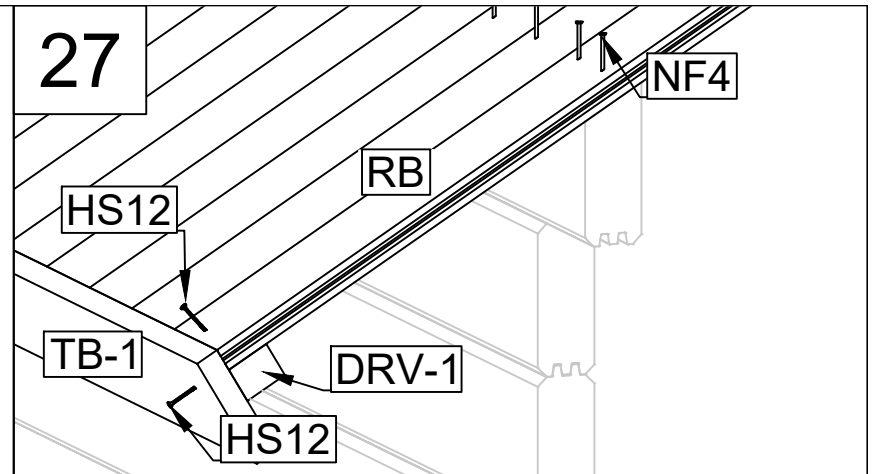
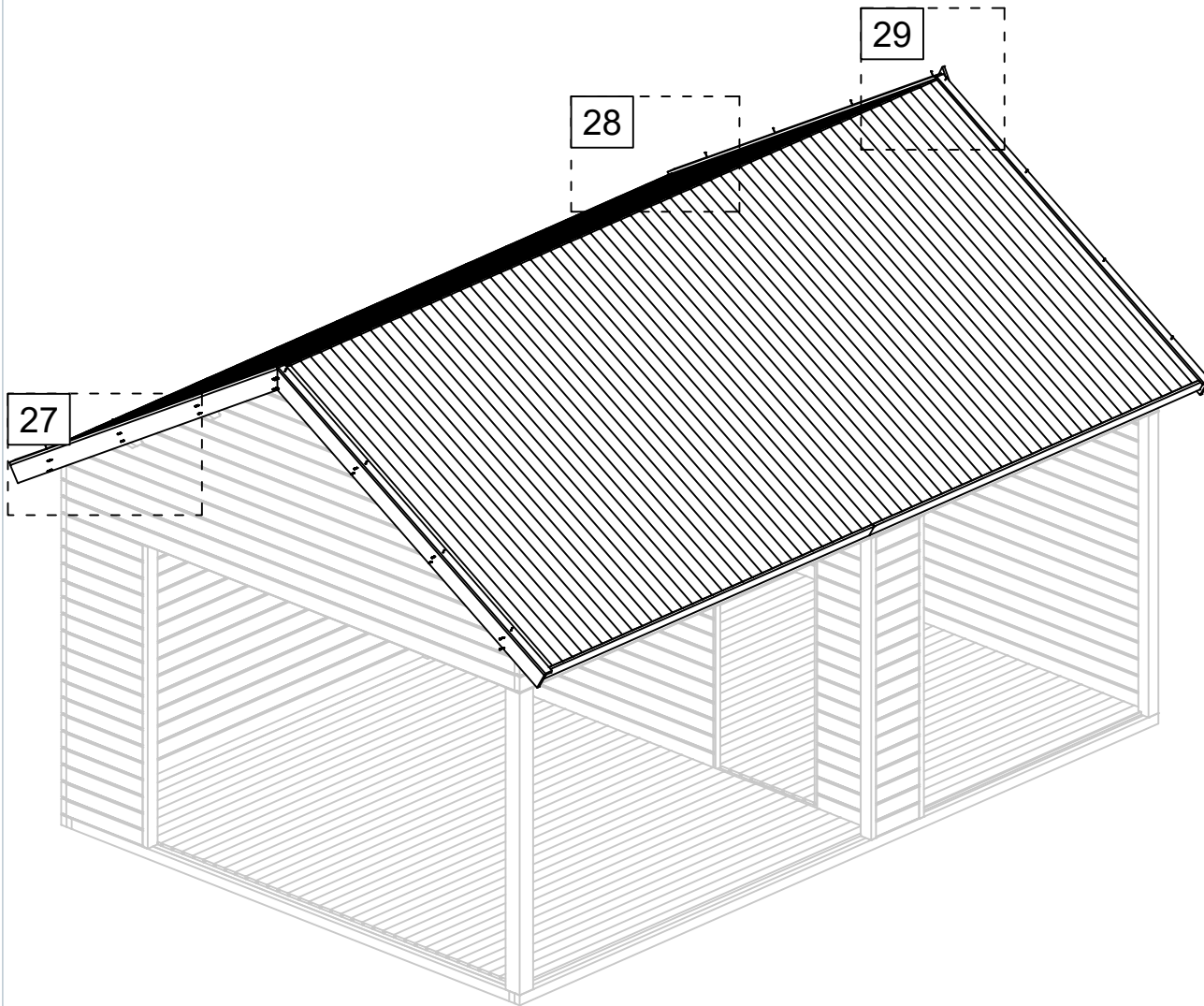



Art. Nr. 4428719

